

**INFORMATION FOR USE FOR MODELS
CODA AUDIO LINUS 5C**

The leading version of this brochure is the English one which shall prevail to the exclusion of the national translation on hand.

Copyright 2010 – 2017 by CODA AUDIO GmbH
Boulevard der EU 6, 30539 Hannover, Germany

Telephone +49 (0) 511 86655888

CODA AUDIO
LINUS 5C

Please visit our website www.codaaudio.com for the latest version of this user manual. Please note that the leading version of CODA AUDIO manuals is always the English one.

IMPORTANT SAFETY INSTRUCTIONS**1. General**

The amplifier may only be used in accordance with the information provided in the user manual. Before and during the usage of the amplifier please ensure that all recommendations, especially the safety recommendations as detailed in the user manual, are adhered to.

The **CODA AUDIO LINUS 5C** amplifier is designed for the amplification of pulsed audio signals. The amplifier should only be connected to speakers with an average impedance as indicated.

2. User Manual

Read the information for use (user manual) and heed all warnings. Keep this user manual in a safe place during the lifetime of the amplifier. The user manual forms an integral part of the amplifier. Reselling the amplifier is only possible if the user manual is available. In case of reselling the amplifier, the reseller has to document any changes made to the amplifier in writing and pass the documentation on to the buyer.

3. Environments

Use this amplifier only in E1, E2, E3, E4 or E5 environments according to EN55103-2 "Electromagnetic compatibility – Product family standard for audio, video, and audio-visual and entertainment lighting control apparatus for professional use – Part 2: Immunity".

4. Mounting/Placement

Do not place this amplifier on an unstable cart, stand, tripod, bracket, or table. The amplifier may fall causing serious injury and serious damage to the product. Any mounting of the amplifier should follow the manufacturer's instructions. Only mounting accessory shall be used which is recommended by the manufacturer.

**5. Mains Connection**

The amplifier may only be connected to a socket with a protective earth connector.

6. Power Cord Protection

Power supply cords should be routed so that they are not likely to be walked on or pinched by items placed upon them or against them, paying particular attention to cords and plugs and the point where they exit from the amplifier.

7. Heat

Do not use this amplifier near any heat sources such as radiators, heat registers, stoves, or other apparatuses that produce heat.

8. Water and Moisture

Do not expose this device to rain or moisture. Do not use this amplifier near water (for example swimming pools and fountains). Do not place any objects containing liquids, such as bottles or glasses, on the top of the unit. Do not splash liquids on the unit. IP-20 equipment. There is no protection against splashing water.

9. Ventilation

Slots and openings in the cabinet are provided for ventilation to ensure reliable operation of the amplifier and to protect it from overheating. These openings must not be blocked or covered. This amplifier should not be installed unless proper ventilation is provided or manufacturer's instructions have been adhered to.

10. Interference Of External Objects and/or Liquids with the Appliance

Never push objects of any kind into this amplifier through openings as they may touch dangerous voltage points or short-out parts that could result in fire or electric shock. Never spill liquid of any kind on the amplifier.

11. Connections

When you connect the amplifier to other equipment, turn off the power and unplug all of the equipment from the supply source. Failure to do so may cause an electric shock and serious personal injury. Read the user manual of the other equipment carefully and follow the instructions when making the connections.

12. Lightning

For additional protection of this amplifier during lightning storms or when it is left unattended and/or unused for long periods of time, unplug it from the wall outlet. This will prevent damage to the amplifier due to lightning and power line surges. Disconnection from the mains power supply can only be achieved by removing the plug from the mains socket and by external disconnecting all poles from the mains.

13. Damages that Require Service

Unplug this amplifier from the mains supply and refer to your dealer/distributor or other authorized repair workshop if any of the following situations occur:

- if liquid has been spilled or objects have fallen into the amplifier
- if the amplifier has been exposed to rain or moisture
- if the amplifier has been dropped or damaged in any other way
- if the power supply cord or plug has been damaged
- when the amplifier exhibits a distinct change from its normal function or performance
- in case the amplifier has been used in a dusty environment for quite a period of time

14. Servicing

All service and repair work must be carried out by a dealer/distributor authorized by **CODA AUDIO**. Do not attempt to service this amplifier yourself. As opening or removing covers may expose you to dangerous voltage or other hazards, the amplifier may only be opened by qualified personnel. Please refer to your dealer/distributor.

15. Spare Parts

When spare parts are required, please ensure that the dealer/distributor only uses spare parts specified by the manufacturer. The use of unauthorized spare parts may result in injury and/or damage through fire or electric shock or other electricity-related hazards.

16. Safety Check

Upon completion of any service or repairs to this product, ask the dealer/distributor to perform safety checks to determine that the amplifier works properly.

Recommendations on how to carry out the safety test can be found in DIN VDE 0701-1 "Maintenance, Modification and Test of Electronic Appliances".

17. Cleaning

Unplug this amplifier from the wall outlet before cleaning. Do not use liquid or aerosol cleaners. Clean only with dry cloth.

18. Packaging and Shipping

When shipping the CODA AUDIO LINUS 5C amplifier, always use the original shipping carton and packing materials. For maximum protection re-pack the unit as it was originally packed at the factory.

19. Altitude (for China)

The amplifier shall be operated at altitudes below or equal 2000 m.



	<p>CAUTION RISK OF ELECTRIC SHOCK DO NOT OPEN</p>		<p>CAUTION – HIGH VOLTAGE HAZARDS EXIST WITHIN THIS PRODUCT. REFER ALL SERVICING TO AUTHORIZED PERSONNEL.</p>
---	--	---	---

	<p>THE LIGHTNING FLASH WITH ARROW HEAD SYMBOL IS INTENDED TO ALERT THE USER TO THE PRESENCE OF UNINSULATED DANGEROUS VOLTAGE WITHIN THE PRODUCT'S ENCLOSURE.</p>
---	--

	<p>THE EXCLAMATION MARK IS INTENDED TO ALERT THE USER TO IMPORTANT INSTRUCTIONS ALSO FOR MAINTENANCE IN THE LITERATURE ACCOMPANYING THE AMPLIFIER.</p>
---	--

	<p>THE LIGHTNING FLASH WITH ARROW HEAD SYMBOL ALERTS THE USER TO DANGEROUSLY HIGH VOLTAGE AT THE OUTPUT CONNECTORS! THAT COULD POTENTIALLY BE LIFE THREATENING.</p>
---	---

	<p>WARNING – TO PREVENT FIRE OR SHOCK HAZARD, DO NOT EXPOSE THIS AMPLIFIER TO RAIN OR MOISTURE.</p>
---	---

	<p>CAUTION – RISK OF ELECTRIC SHOCK – DO NOT OPEN.</p>
---	--

	<p>THE AMPLIFIER SHALL ONLY BE OPERATED AT ALTITUDES BELOW OR EQUAL 2000 M.</p>
---	---

	<p>THE AMPLIFIER MAY ONLY BE CONNECTED TO A SOCKET WITH A PROTECTIVE EARTH CONDUCTOR.</p>
---	---

EC Declaration Of Conformity In Accordance To EC Directives:
Electromagnetic compatibility (Council Directive 2014/30/EC);
Low-voltage electrical equipment (Council Directive 2014/35/EC)



Manufacturer's Name:

Coda Audio GmbH

Manufacturer's Address:

Boulevard der EU 6, 30539 Hannover, Germany

Declares That The Product With The Model Name:

LINUS 5C

Conforms to the following standards:

> IEC/EN/UL/CSA 60065 Safety

The operating conditions and application environments presupposed in the information for use (user manual) are to be kept accordingly.

Hannover, 02.02.2015

A handwritten signature in black ink, appearing to read 'S. Alexandrov', is written over a light blue horizontal line.

Svetlomisr Alexandrov

EC DECLARATION OF CONFORMITY

Consignes de Sécurité Importantes

1. Général

L'amplificateur ne doit être utilisé qu'en conformité avec les informations indiquées dans le mode d'emploi. Avant et pendant l'utilisation de l'amplificateur, s'assurer que toutes les consignes, surtout les consignes de sécurité décrites dans le mode d'emploi, sont respectées.

L'amplificateur **LINUS 5C** a été construit pour l'amplification de signaux audio pulsés et ne doit être branché qu'à des enceintes ayant une impédance moyenne de celle indiquée.

2. Mode d'Emploi

Conserver ce mode d'emploi dans un endroit sûr durant toute la vie utile de l'amplificateur. Ce mode d'emploi fait partie intégrante de cet amplificateur. La revente de l'amplificateur n'est possible qu'avec le mode d'emploi. Tout changement subi par l'amplificateur doit être documenté par écrit et transmis à l'acheteur dans le cas d'une revente.

3. Environnement

N'utiliser cet amplificateur que dans les environnements classés E1, E2, E3, E4 ou E5 selon EN55103-2 „Compatibilité électromagnétique – Norme de famille de produits pour les appareils à usage professionnel audio, vidéo, audiovisuels et de commande de lumière pour spectacles - Partie 2: immunité“.

4. Instruction de montage

Ne pas placer cet amplificateur sur un chariot, un stand, un trépied, un support ou une table instable. Le produit pourrait chuter, s'endommager sérieusement, et provoquer de graves blessures.

Pour l'installation de l'amplificateur, observer les instructions du fabricant et utiliser les accessoires recommandés par le fabricant.



5. Connection Secteur

Ne brancher cet amplificateur uniquement à une prise reliée à la terre.

6. Protection du cordon d'alimentation

Les câbles électriques sont à disposer de manière à ne pas être piétinés ou coincés par des objets placés dessus ou contre les câbles, tout en faisant attention aux câbles et aux fiches et particulièrement au point de sortie de l'amplificateur. Le dispositif de déconnexion du secteur (le câble et connecteur secteur ou le disjoncteur thermique) doivent être accessibles à tout instant.

7. Chaleur

Ne pas brancher près de sources de chaleur comme les radiateurs, les corps de chauffe, les fourneaux ou d'autres dispositifs qui produisent de la chaleur.

8. Eau et humidité

Ne pas exposer le produit à la pluie ou à l'humidité, ne pas utiliser le produit à proximité d'eau et ne pas utiliser le produit s'il est mouillé (p.ex. dans des pièces humides ou près d'une piscine). Ne placez jamais des objets contenant des liquides sur le produit (comme par exemple des bouteilles ou des verres). Il s'agit d'un produit IP20 sans protection contre éclaboussure.

9. Ventilation

Les fentes et les ouvertures dans la boîte servent à la ventilation et assurent un bon fonctionnement de l'amplificateur, tout en le protégeant de la surchauffe. Ces ouvertures ne doivent être ni bloquées ni couvertes. Le produit peut être installé uniquement dans un endroit convenablement ventilé, selon les recommandations du fabricant données dans ce manuel.

10. Interférence d'objets externes et/ou liquides avec l'amplificateur

Ne jamais introduire d'objets quelconques dans l'amplificateur à travers les ouvertures car ils peuvent être en contact avec des points de tension dangereuse ou causer un court-circuit de composants provoquant ainsi un feu ou un choc électrique. Ne jamais renverser de liquide sur l'amplificateur.

11. Branchment

Pour brancher l'amplificateur à d'autres dispositifs, éteindre le courant et débrancher tous les composants du réseau. Autrement, il y a un risque de choc électrique et de lésions sérieuses. Lire attentivement le mode d'emploi des autres dispositifs et suivre les instructions en branchant.

12. Foudre

Pour une protection renforcée de cet amplificateur, le débrancher de la prise secteur pendant les orages ou quand il est sans surveillance et hors utilisation pendant un temps prolongé. Ainsi, vous évitez un endommagement de l'amplificateur dû aux coups de foudre et des surtensions. Le débranchement du réseau n'est possible qu'en retirant la prise secteur ou en débranchant tous les contacts du réseau.

13. Dommages nécessitant une intervention

Dans les cas suivants, débranchez l'amplificateur du réseau et contactez votre concessionnaire/distributeur ou un atelier autorisé :

- > du liquide a été renversé ou des objets sont tombés dans l'amplificateur
- > l'amplificateur a été exposé à la pluie ou à l'humidité
- > si l'amplificateur est tombé ou a été abîmé
- > le cordon d'alimentation ou la fiche électrique est endommagé
- > l'amplificateur ne marche pas de manière normale comme décrit dans le mode d'emploi

14. Entretien

Toute opération de maintenance ou réparation doit être effectuée par un concessionnaire autorisé **Coda Audio**. Ne pas essayer d'entretenir l'amplificateur vous-même. L'ouverture ou l'enlèvement de couvercle pourrait vous exposer à une tension dangereuse ou à d'autres risques, l'amplificateur ne doit être ouvert que par du personnel qualifié. Veuillez contacter votre concessionnaire/distributeur.

15. Réparation et pièces de rechange

S'il faut des pièces de rechange, s'assurer que le concessionnaire/distributeur n'utilise que les pièces de rechange spécifiées par le constructeur. L'emploi de pièces de rechange non autorisées peut causer des lésions et/ou des endommagements par feu, choc électrique, ou d'autres dangers d'origine électrique.

16. Contrôle de sécurité

Après entretien ou réparation de ce produit, demander au concessionnaire/distributeur de faire des contrôles de sécurité pour déterminer si l'amplificateur est en bon état de marche.

Des conseils pour les contrôles de sécurité se trouvent dans la norme DIN VDE 0701-1 „Entretien, modifications et test des appareils électriques“.

17. Nettoyage

Débrancher l'amplificateur de la prise secteur avant de le nettoyer. Ne pas utiliser des produits liquides ou vaporisés.

18. Emballage et expédition

Pour expédier l'amplificateur **LINUS 5C** veuillez toujours utiliser le carton et l'emballage d'origine. Pour une protection maximale, toujours emballer l'unité comme elle l'a été à sa sortie d'usine.

19. Altitude (pour la Chine)

L'amplificateur ne doit pas être utilisé à des altitudes dépassant 2000 m.





ATTENTION
RISQUE DE CHOC ÉLECTRIQUE
NE PAS OUVRIR



ATTENTION – CE PRODUIT PRÉSENTE
DES RISQUES ASSOCIÉS AU
COURANT ÉLEVÉ. TOUT SERVICE
DOIT ÊTRE EFFECTUÉ PAR DU
PERSONNEL AUTORISÉ.



L'ÉCLAIR AVEC LE SYMBOLE DE LA FLÈCHE SERT À AVERTIR
L'UTILISATEUR DE LA PRÉSENCE D'UNE TENSION NON ISOLÉE À
L'INTÉRIEUR DE LA CAISSE.



LE POINT D'EXCLAMATION SERT ÉGALEMENT À AVERTIR L'UTILISATEUR
D'INSTRUCTIONS IMPORTANTES POUR L'ENTRETIEN CONTENUES DANS
LA DOCUMENTATION DE L'AMPLIFICATEUR.



L'ÉCLAIR AVEC LE SYMBOLE DE LA FLÈCHE INDIQUE À L'UTILISATEUR
LA PRÉSENCE DE COURANT ÉLEVÉ AUX CONNECTEURS SPEAKER QUI
POURRAIENT PRÉSENTER UN DANGER DE MORT.



AVERTISSEMENT – POUR ÉVITER DU FEU OU DES CHOCES
ÉLECTRIQUES, NE PAS EXPOSER CET AMPLIFICATEUR À LA PLUIE
OU À L'HUMIDITÉ.



ATTENTION – RISQUE DE CHOC ÉLECTRIQUE – NE PAS OUVRIR.



L'AMPLIFICATEUR NE DOIT PAS ÊTRE UTILISÉ À DES ALTITUDES
DÉPASSANT 2000 m.



NE BRANCHER CET AMPLIFICATEUR UNIQUEMENT À
UNE PRISE RELIÉE À LA TERRE.

Déclaration de conformité CE



Déclaration de conformité CE selon les directives CE:

Compatibilité électromagnétique (Directive 2014/30/CE Conseil Européen)
Basse tension (Directive 2014/35/EC du Conseil Européen)

Nom du constructeur:

Coda Audio GmbH

Adresse du constructeur:

Boulevard der EU 6, 30539 Hannover, Germany

Déclare que le produit avec le nom de modèle:

Amplificateur **LINUS 5C**

Est en conformité avec les normes suivantes:

- > IEC/EN/UL/CSA 60065 Sécurité
EN55103-1 Émission

Les conditions de service et les environnements spécifiés dans le mode d'emploi sont à respecter.

Hannover, 02.02.2015

Svetlomid Alexandrov

DÉCLARATION DE CONFORMITÉ CE

P.2	IMPORTANT SAFETY INSTRUCTIONS	P. 19	4 OPERATION	P. 34	8 SERVICE INFORMATION
P.4	EXPLANATION OF SYMBOLS		4.1 Screen user interface	P. 35	9 MAINTENANCE INFORMATION
P.5	EC DECLARATION OF CONFORMITY	P. 26	4.2 Indicators		10 DECOMMISSIONING
P.6	CONSIGNES DE SÉCURITÉ IMPORTANTES		4.2.1 Limit LED	P. 36	COMPANY INFORMATION
P.8	EXPLICATION DES SYMBOLES		4.2.2 Input Signal LED	P. 37	NOTICES/CHANGES MADE TO THE
P.9	DÉCLARATION DE CONFORMITÉ EC				AMPLIFIER
P.10	CONTENTS	P. 27	4.3 Power Amp Protection Systems		
P.11	1 WELCOME		4.3.1 DC Protection		
	1.1 Welcome To CODA AUDIO		4.3.2 DC Servo		
P.12	2 THE AMPLIFIER		4.3.3 Overcurrent Protection		
	2.1 Unpacking		4.4 Mains Protections		
	2.2 The Amplifier		4.4.1 Inrush Current Limitation		
P. 13	2.3 LINUS 5C – The Front		4.4.2 Mains Overvoltage Detection		
	2.4 LINUS 5C – The Rear		4.5 Main SMPS Protections		
P. 14	2.5 Factory settings		4.5.1 Overcurrent Protection		
	3 INSTALLATION		4.5.2 Overload Protection		
	3.1 Mounting		4.5.3 Thermal Protection		
P. 15	3.2 Cooling		4.6 Fans		
	3.3 Mains	P. 28	5 SPECIFICATION		
	3.3.1 Mains supply	P. 31	6 TYPICAL PERFORMANCE DIAGRAMS		
P. 16	3.3.2 Inrush current limitation	P. 33	7 WARRANTY INFORMATION		
	3.3.3 Mains power consumption and current draw		7.1 Summary of Warranty		
P. 17	3.4 Signal inputs		7.2 Items Excluded from This Warranty		
	3.4.1 Analog Input		7.3 What CODA AUDIO Will Do		
	3.4.2 AES/EBU Input/Output		7.4 How to Obtain Warranty Service		
	3.5 Remote control inputs (Ethernet)		7.5 CODA AUDIO's Product Improvement		
P. 18	3.6 Power Outputs				
	3.6.1 SPEAKON® Connection				

1 Welcome to CODA AUDIO

Coda Audio – designer and manufacturer of highest quality speaker systems

Coda Audio is a leading designer and manufacturer of high quality pro-audio loudspeaker systems.

Core to our products are a number of unique patented driver technology designs which provide outstanding dynamic results as well as improved precision and reliability over conventional components.

To ensure the highest quality and control over our products we have our own manufacturing facility in Europe which produces all of the driver and cabinet components. Further benefits to this approach include substantial reductions in cost and quicker times to market for new products.

We have a wide product range offering high quality solutions to satisfy the most discerning and complex professional sound reinforcement applications, ranging from portable to installation to touring.

Coda Audio is represented via a global network of experienced and technically qualified international distributors.

We believe that the best way to get to know us better is by listening to our loudspeakers because:

HEARING IS BELIEVING

2.1 Unpacking

Please unpack and inspect your new amplifier for any damage that may have occurred during transit. If damage is found, notify the transportation company immediately. Only you as the consignee may initiate a claim for shipping damage. **CODA AUDIO** will be happy to cooperate fully as needed. Please save the shipping carton as evidence of damage for the shipper's inspection.

Even if the amplifier has arrived in perfect condition, save all packing materials for any future transport of the unit.

When shipping the **LINUS 5C** amplifier, always use the original shipping carton and packing materials. For maximum protection, repack the unit as it was originally packed at the factory.

NOTE: Never ship the amplifier without the original packaging materials.

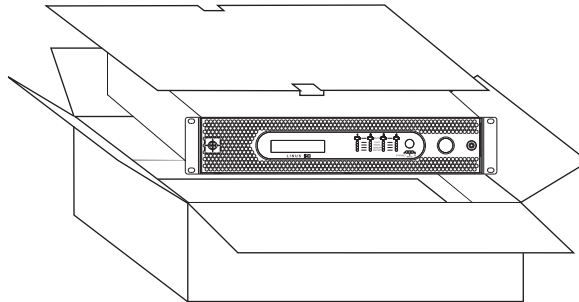

2.2 The Amplifier

The **LINUS 5C** amplifiers offer a power output of:

1600 W peak per channel @ 4 Ohm
2800 W peak per channel @ 2 Ohm

Using a bipolar class D high efficiency power amplifier output stage. For a complete overview of rated power data please refer to chapter 5 Specifications.

The **LINUS 5C** power amplifier is fitted with a fixed voltage power supply.

The **LINUS 5C** also uses a microprocessor for controlling and monitoring the power amp. This has four main advantages over more traditional power amp systems:

1. Integrated Remote Control
2. Extreme fast and accurate monitoring of all amplifier parameters
3. Fast detection of failures
4. Very fast triggering of protection features

The **LINUS 5C** has been designed as an intelligent and powerful amplifier for performing specialised tasks within a complex audio system. Users can adapt the power amp to meet their specific audio requirements before use. The display mounted on the front of the **LINUS 5C** amplifier allow the different functions to be accessed. Since there are a lot of parameters available, it is important that users should familiarize themselves thoroughly with the entire range of settings and programmable features before using the power amp. If you have any questions regarding features and/or functions of your **LINUS 5C** amplifier, **CODA AUDIO** will be pleased to provide you with further information. Alternatively, contact your dealer or distributor.

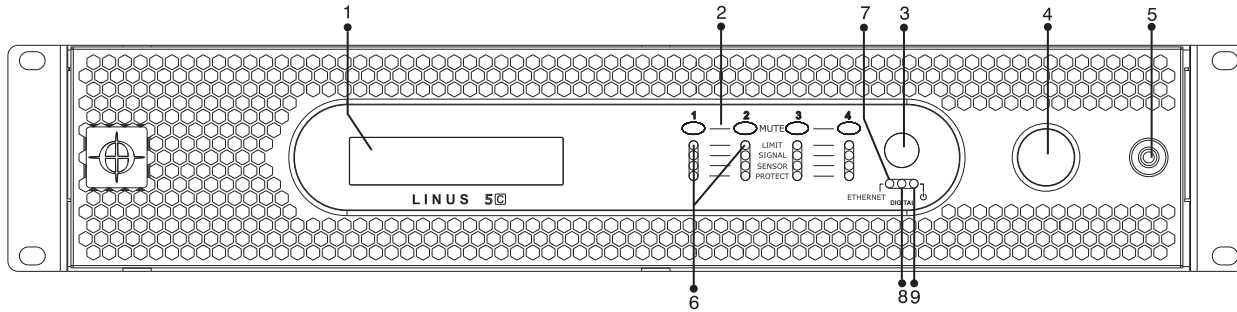

2.3 LINUS5C–The Front

- 1 Display
- 2 Channel Mute Buttons
- 3 Rotary Encoder Knob
- 4 1/0 Standby Power Switch
- 5 Knurled Grillscrew

- 6 LED's
- 7 Ethernet-Connection LED
- 8 DAN-Connection LED
- 9 Mains-Connection LED

2.4 LINUS5C–The Rear

- 10 AC Power Connector
- 11 SPEAKON® Connectors
- 12 Cooling Air Outlet Vents
- 13 XLR – Line Inputs
- 14 Ethernet Connector for remote access
- 15 LINET Network Connections
1IN / 1OUT (AES/EBU)

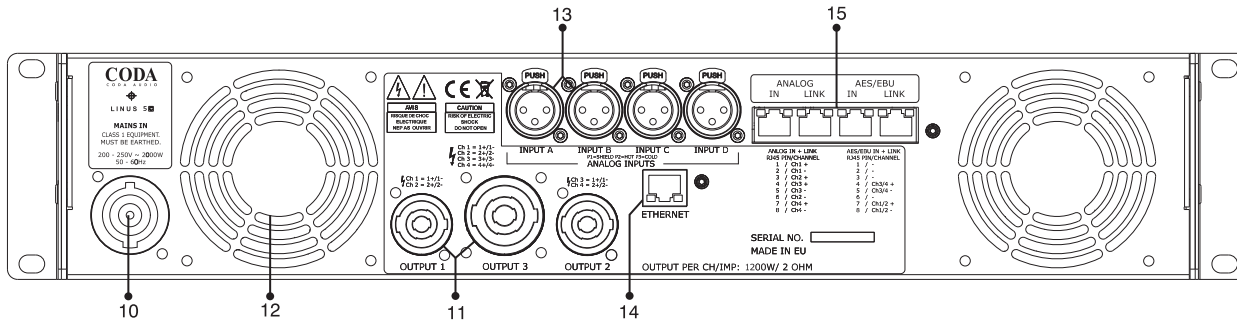

2.5 Factory settings

LINUS 5C amplifiers are delivered with the following factory settings

Power Status	Amplifier is switched Off
Input Selection	Analog
AmpGain	32 dB
Output Mode	Quad Channel
Mute	All channels inactive (muted)
Level Attenuator	0 dB all channels
Clip Limiter	On
DSP	On
Lock Device	Unlocked
Ethernet Settings	192.168.1.1
Ethernet Mask	255.255.0.0
Ethernet Gateway	192.168.1.1

3.1 Mounting

Use four screws and washers when mounting the amplifier to the front rack rails. For mobile use, the amplifier should also be secured using the 19" mounting elements on the rear panel.

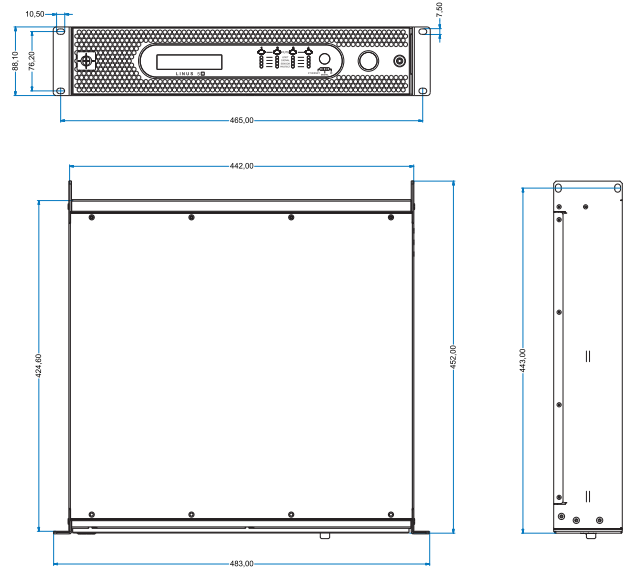

3.2 Cooling

Under normal operation of the power amp, overheating should never be a problem. The air is taken in from the front and out through the back. It is of course essential that, while the power amp is running, the air is able to circulate around it freely. The efficiency of the cooling will depend on both the immediate environment (e.g. an enclosed rack, direct sunlight) and that the front filter is clogged. If the amp is installed in a case, the open area at the back of the case must be at least 140 cm². This area should be in line with the amp. If this cannot be achieved, a forced ventilation system has to be used.

3.3. Mains

3.3.1 Mains supply

Only connect the LINUS 5C amplifier to an appropriate AC circuit and outlet in accordance with the requirements indicated in the second line on the rating plate. Only use mains cables with original Neutrik powerCON[®] 32 A connectors for safety reasons.

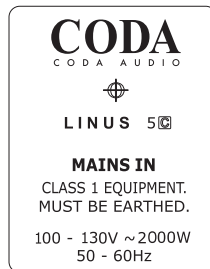
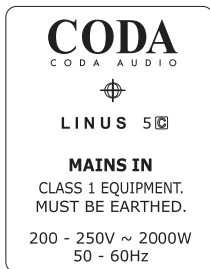

For installation mains cable and amplifier protection, we recommend the use of a 16 A mains breaker with C-type tripping characteristic for 230 V operation for *each* LINUS 5C amplifier! (or a 30 – 32 A breaker for 120 V operation respectively)

Please do NOT use much larger mains breakers than recommended here and especially do NOT connect several LINUS 5C amplifiers to one single (very large) breaker.

Always respect this rule of thumb for good installation practice for guaranteeing long term reliable, robust and safe operation:

One LINUS 5C – One circuit breaker

As soon as the amplifier is connected to mains, the primary capacitors are charged through the inrush current limiter. At the same time the auxiliary power supply is activated, generating a 5 V standby voltage to the main controller and the display. This allows powering up the main SMPS from the switch on the amplifiers front panel.

NOTE: Turning the amplifier off from the user interface (1/0 switch) does not disconnect the amplifier from mains. Disconnecting the amplifier from the mains can only be achieved by physically removing / disconnecting the mains cable. The mains cable therefore has to be freely accessible at all times. Attention: Never unplug the powerCON[®] connector while the amplifier is playing music. Always turn the amplifier off from the display menu before disconnecting the powerCON[®] connector.

Alternatively, you can disconnect the amplifier from the mains via an external all-pole disconnection (e.g. a mains breaker).

Disconnect the mains cable during a lightning storm or when the amplifier remains unused or unsupervised for a prolonged period of time. If a power cut occurs while the amplifier is switched on, it will restart automatically once the mains distribution has been restored. All settings prior to the loss of power will be maintained.

3.3.2 Inrush current limitation

This limiter will take action anytime:

- when connecting the amplifier to the mains through the mains cable
- when switching the amplifier on through an external mains breaker
- the mains voltage was lost for at least 4 half-cycles or more (e.g. a short voltage drop)

This limiter will confine the mains current to a value smaller than $20 A_{rms}^*$.

*: maximum rms value of inrush current over one half-cycle of the mains voltage according to DIN EN 55103-1.

NOTE: Even under normal conditions the mains current can reach levels up to 32 A / 64 A (230 V / 120 V) and even higher for very short periods of time. This could cause lamps to flicker if connected to the same mains as the amplifier. The impedance of the AC circuit should be less than $0,157 \Omega$ to avoid flicker according to EN61000-3-11 "Electromagnetic compatibility – Part 3-11: Limits – Limitation of voltage changes, voltage fluctuations, and flicker in the public low-voltage supply systems – Equipment with rated current ≤ 75 A and subject to conditional connection". If in any doubt, consult your local power provider. Never attempt to measure this impedance level with your ohmmeter. This may damage your meter and expose you to the risk of electric shock!

3.3.3 Mains power consumption and current draw

Due to the huge output power of the **LINUS 5C**, the mains current draw can get very high when demanding large output powers. Please refer to following table for an overview of mains currents and power consumption under different operating conditions.

Operating condition	Mains current (4 Ω)	Power consumption (4 Ω)	Output power
Amplifier standby (power off)	0,12 A	27 W	0 W
Idle (amplifier powered on)	0,51 A	115 W	0 W
75 W per channel / $\frac{1}{8}$ th	2,2 A	495 W	300 W
150 W per channel / $\frac{1}{4}$ th	3,8 A	851 W	600 W
200 W per channel / $\frac{1}{3}$ rd	5,0 A	1100 W	800 W

Mains current draw and power consumption @ 230 V, 50 Hz

Measured with pink noise with crest factor of 12 dB to represent typical music signal.

For 120 V mains operation, the current values can be multiplied by 2.

Please note that the values given here are typical values only, measured on a standard 230 V / 50 Hz outlet. The actual mains current draw can vary depending on the music signal and the mains characteristics (especially the mains impedance) of any specific installation.

3.4 Signal inputs

The **LINUS 5C** amplifier offers two different input signal sources:

Analog

In this mode the analog signals connected to the XLR input connectors will be used as input signal. There are additional RJ45 connectors for Analog connections. These are wired parallel to the XLR inputs.

AES/EBU

With the AES/EBU setting the input signals are taken from the RJ45 connection.

3.4.1 Analog Input

XLR:

Pin 1 = Ground (to chassis / earth)

Pin 2 = Hot (in-phase, "+")

Pin 3 = Cold (out of phase, "-")

Analog RJ45 Pin Wiring

RJ45-Pin	Color	Channel (Polarity)
1	Orange-White	1 (+)
2	Orange	1 (-)
3	Green-White	2 (+)
4	Blue	3 (+)
5	Blue-White	3 (-)
6	Green	2 (-)
7	Brown-White	4 (+)
8	Brown	4 (-)

We suggest to always use symmetrically (balanced) shielded cable to connect the amplifier.

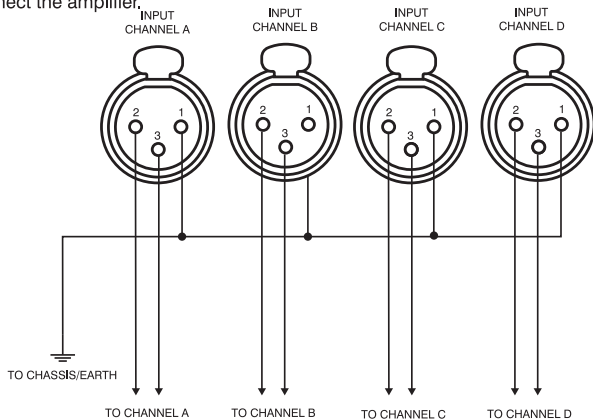

The **LINUS 5C** amplifier has a 32 dB voltage gain.

The table shows input sensitivity per channel for a given gain and load.

Model	rated output power	32 dB
LINUS 5C	2800 W @ 2 Ω	1,32 V
	1600 W @ 4 Ω	1,41 V
	900 W @ 8 Ω	1,50 V

3.4.2 AES/EBU Input / Output

The AES/EBU input and output connectors allow you to receive and send multichannel digital audio streams to other AES /EBU-compatible devices (like other **LINUS 5C** amplifiers for example). Please note that although the AES/EBU connectors use the same connector type than standard Ethernet (RJ-45), the physical transmission protocols are different. So any direct connection between the AES/EBU connectors and standard Ethernet connectors will not work.

AES/EBU RJ45 Pin Wiring

RJ45-Pin	Color	Channel (Polarity)
1	Orange-White	-/-
2	Orange	-/-
3	Green-White	-/-
4	Blue	3/4 (+)
5	Blue-White	3/4 (-)
6	Green	-/-
7	Brown-White	1/2 (+)
8	Brown	1/2 (-)

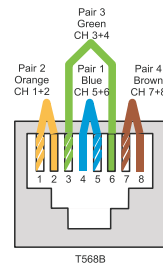

3.5 Remote control inputs (Ethernet)

The Ethernet Link network connector allows you to access the **LINUS 5C** from a host computer for remote control, firmware update and downloading DSP presets. Please note that for setting up proper network connection you need to use the **CODA AUDIO LINUS-Live** software.

3.6 Power Outputs

3.6.1 SPEAKON® Connection

Both SPEAKON® connectors are connected to the channel A and channel B amplifier outputs. Note that the wiring configuration of the second (bottom) SPEAKON® connector is inverted (channel A and B outputs swapped).

The pin configuration of the SPEAKON® connectors is as follows:

Left SPEAKON®:	Pin 1+	Channel A amplifier output
	Pin 1-	Channel A ground
	Pin 2+	Channel B amplifier output
	Pin 2-	Channel B ground

Right SPEAKON®:	Pin 1+	Channel C amplifier output
	Pin 1-	Channel C ground
	Pin 2+	Channel D amplifier output
	Pin 2-	Channel D ground

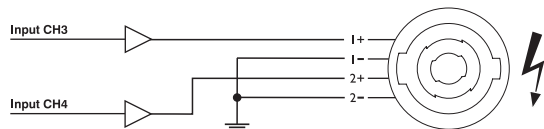
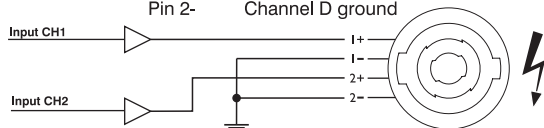

Center SPEAKON®:	Pin 1+	Channel A amplifier output
	Pin 1-	Channel A ground
	Pin 2+	Channel B amplifier output
	Pin 2-	Channel B ground
	Pin 3+	Channel C amplifier output
	Pin 3-	Channel C ground
	Pin 4+	Channel D amplifier output
	Pin 4-	Channel D ground

WARNING!

SPEAKON® connectors marked with the lightning flashes indicate high voltages that are potentially life threatening.

Wiring to these terminals requires installation by an instructed person or the use of ready-made leads or cords.

Custom wiring should only be carried out by qualified personnel.

To prevent electric shock, do not operate the amplifier with any of the conductor portion of the speaker wire exposed.

NOTE: For reasons of safety and performance do only use high-quality fully insulated speaker cables of stranded copper wire. Use the largest wire size that is economically and physically practical. Make sure that the cables are not longer than necessary.

IMPORTANT: When connecting speaker cabinets in parallel (especially in Parallel Mono operation mode), always use both SPEAKON® connectors where possible for current sharing. Not doing so may cause permanent damage to the connectors and may considerably reduce performance.

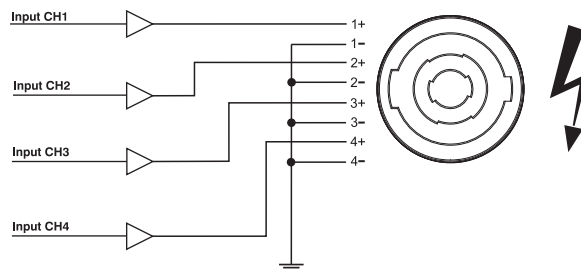

4.1 Screen User Interface

• **Indication:**

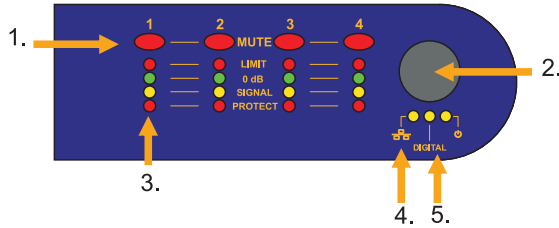

1. Channel mute/ action buttons
2. Rotary encoder knob. Selects, changes and enter parameters
3. Signal, Limit, protect LED's
4. Ethernet connection LED
5. Digital input signal selected (LINET-C) LED

1. Menu

- Press the Rotary Encoder Knob to enter the Menu



2. Select Input

- Rotate the Encoder to the point 01: SELECT INPUT



- Press the Encoder Knob to enter the input source selection



- Press and hold (1) Channel action button for the appropriate channel and rotate the Encoder Knob (2)

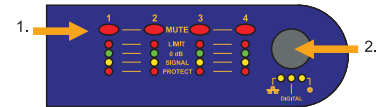

Example shows Channel 1 selected and digital input channel 1 is routed to output 1
(in 2 -> out 2, in 3-> out 3,...)

Input Routing topology
Analog = A,B,C,D
Digital = 1,2,3,4

Input	Source	CH=0
A	B	C D

Input	Source	CH=1
1	2	3 4

3. Input Gain

- Rotate the Encoder to the point 02: INPUT GAIN



- Press the Encoder Knob to enter Gain selection

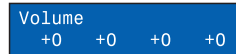

- Press and hold (1) Channel action button for the appropriate channel and rotate the Encoder Knob (2)

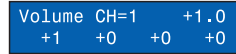

Example shows Chanel 1 selected with +1.0 dB Gain value

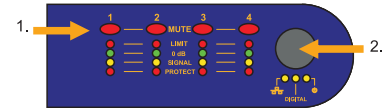

4. Input Delay

- Rotate the Encoder to the point 03: INPUT DELAY



- Press the Encoder Knob to enter Delay selection

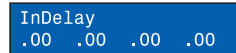

- Press and hold (1) Channel action button for the appropriate channel and rotate the Encoder Knob (2)

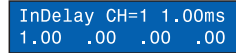

Example shows Chanel 1 selected with 1.00ms Delay

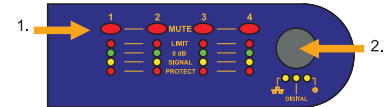

Info: You can select a larger scroll value by pressing the Rotary encoder knob and vice versa
Maximum 200ms input Delay per Channel

6. Tuning

-Rotate the Encoder to the point 04: TUNING 1

▶: TUNING 1
5: TUNING 2 ◀

- Press the Encoder Knob to enter Tuning page

In1 Tuning: HF-Shelf
HF .0

- Press and hold (1) Channel action button 3 and rotate the Encoder Knob (2) to change Gain value

In1 Tuning: Gain
HF 1.0

Example shows Chanel 1 High Shelf selected with +1.0 dB Gain value

- To change the Tuning Tool press and hold (1) Channel action button 1 and rotate the Encoder Knob (2) to change Tuning Tool

In1 Tuning: Mode
Huma .0

Example shows Chanel 1 Selection mode active, Human Tuning Tool selected

- Tuning Tool Overview

In1 Tuning: HF-Shelf
HF .0

High Shelf (fixed frequency and Q-Factor)

In1 Tuning: LowBoost
LowB .0

Low Shelf (fixed frequency and Q-Factor)

In1 Tuning: Distance
Dist .0

Distance - High Frequency Airabsorbion correction

In1 Tuning: Array
ARR. 8

Array Funktion - Line Arraylength adjustment (Only for Line Arrays!)

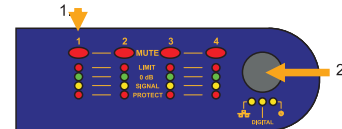
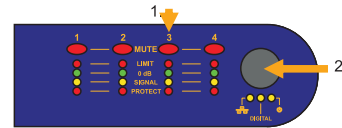

In1 Tuning: Human
Huma .0

Human EQ (fixed frequency and Q-Factor)

In1 Tuning: SubSonic
Subs .0

Sub Sonic Filter (Low Shelf (fixed frequency and Q-Factor))

In1 Tuning: PEQ1
PEQ1 1000 .0 3.0

Parametric Eq - Free configurable (4x PEQ's available)

In1 Tuning: Sizing
SIZE 1.0

Sizing - Virtually increase or decrease Systemsize

6. Tuning

-Parametric EQ configuration

Select Frequency

In1 Tuning: Freq
PEQ1 1000 .0 3.0

- Press and hold (1) Channel action button 2 and rotate the Encoder Knob (2) to change Frequency

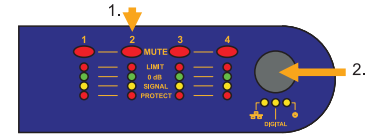

Select Gain

In1 Tuning: Gain
PEQ1 1000 .0 3.0

- Press and hold (1) Channel action button 3 and rotate the Encoder Knob (2) to change Gain value

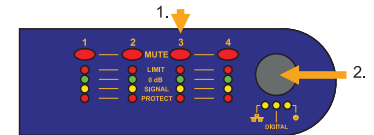

Select Q-Factor

In1 Tuning: Quality
PEQ1 1000 .0 3.0

- Press and hold (1) Channel action button 4 and rotate the Encoder Knob (2) to change Quality Factor

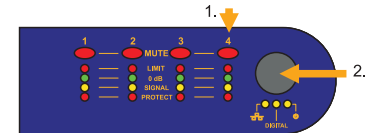

-Array Function

In1 Tuning: Count
ARR. 8

- Press and hold (1) Channel action button 2 and rotate the Encoder Knob (2) to change Array Count

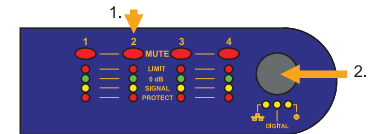

-Sizing

In1 Tuning: Gain
SIZE 1.0

- Press and hold (1) Channel action button 3 and rotate the Encoder Knob (2) to change virtually the System Size

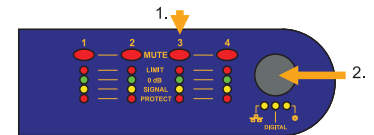

7. Lock Unit

-Rotate the Encoder to the point 08: LOCK



-Press and hold (1) Channel action button 1 to Lock the Display



The Lock Symbol in the main display represents a locked display



-To unlock the Display Rotate the Encoder to the point 08: LOCK



-Rotate the Encoder Knob (1) to type in Password press and hold (2) Channel action button 1 to Unlock the Display

Password to Unlock Display will be provided by the manufacturer

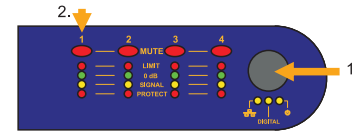
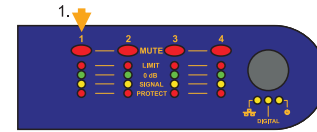

8. Select Preset

-Rotate the Encoder to the point 08: LOCK



- Press the Encoder Knob to enter Preset selection page



-Rotate the Encoder Knob (1) to select Preset, press Encoder knob for 4 sec. to confirm preset selection

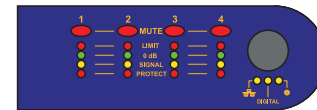

-If the Amplifier has been connected to LINUS LIVE before, the Group parameters need to be cleared first! Repeat the above mentioned steps in Preset Selection to clear group

9. Store Preset

-Rotate the Encoder to the point A: STORE PRESET

→A: STORE PRESET ←
B: SET IP

- Press the Encoder Knob to enter Store Preset page

STORE PRESET Press b
P 1: D5xPW12omni100

- Rotate the Encoder Knob (1) to Select preset number for storage and press Encoder Knob 4 sec. to store

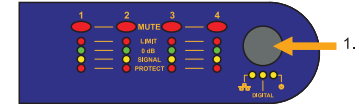

Info:

Preset numbers 1 to 20 are User Presets which can be used as storage positions for customized User Presets. Preset Names can't be renamed (only in Preset Builder)

10. Set IP

-Rotate the Encoder to the point B: SET IP

→B: SET IP ←
C: SYSTEM TEMP

- Press the Encoder Knob to enter IP Address Setup page

CHANGE IP press b
1: 192.168. 1. 1

- Rotate the Encoder Knob (1) to Select module number (change IP Address). Press Encoder 4 sec to accept

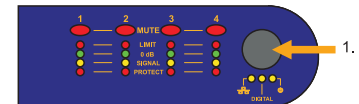

11. System Temperature

- Rotate the Encoder to the point C: SYSTEM TEMP

→C: SYSTEM TEMP ←
C: SYSTEM TEMP

- Press the Encoder Knob to enter Module Temperature page

MODULE TEMPERATURE
33C 306K 91F

12. Backlight

-Rotate the Encoder to the point D: BACKLIGHT



- Press the Encoder Knob to enter Backlight setup page

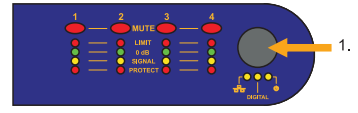

- Rotate the Encoder Knob (1) to select option for permanent backlight or auto deactivate (after 25 sec)

13. Info

-Rotate the Encoder to the point E: INFO



- Press the Encoder Knob to enter Info page



4.2 Indicators

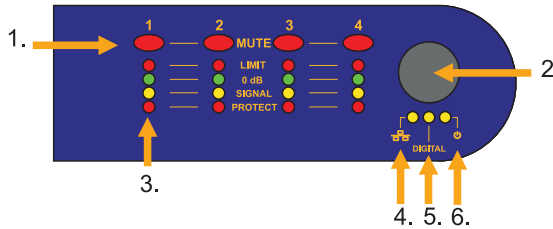

• Indication:

1. Channel mute/ action buttons
2. Rotary encoder knob. Selects, changes and enter parameters
3. Signal, Limit, protect LED's
4. Ethernet connection LED
5. Digital input signal selected (LINET-C) LED
6. Power LED

4.2.1 Limit LEDs

This LED indicates an overloading of the corresponding amplifier channel.

4.2.2 Input Signal LEDs

The Signal LED is illuminated when the input signal level is -45dBu or -60dBFS and are unaffected by the DSP output settings.

Note that these LED's are driven only by the input signal and will therefore also be active if all output channels are muted.

4.3 Power Amp Protection Systems

4.3.1 DC Protection

Each output of the power amp is constantly monitored for persistent DC voltage levels. If the 10 V threshold voltage is exceeded at any of the outputs, the corresponding channel will be automatically switched off. A DC issue can be located in the output stage, the driver stage, or at the input of the amplifier.

Output Stage

When a persistent DC voltage is located at an output stage, the main SMPS will be permanently switched off. This will be indicated on the display.

4.3.2 DC Servo

To prevent DC Offset at the speaker output, the **LINUS 5C** amplifiers are fitted with four DC Servos (hence there are no capacitors in the signal path!).

4.3.3 Overcurrent Protection

The output stage is permanently monitored for possible current surges. There are two limiting levels of overcurrent depending on output voltage. These limits will be set automatically. This improves reliability without degrading sound quality when driving complex loads.

4.4 Mains Protections

4.4.1 Inrush Current Limitation

Within 2 seconds of the **LINUS 5C** amplifiers being connected to the mains, the inrush current limiter will charge the primary capacitances in a controlled way, limiting the maximum mains current during startup.

4.4.2 Mains Overvoltage Detection

There is NO overvoltage protection! The customer needs to be sure to only use the LINUS 5C in the voltage range printed on the label on the back of the unit!

4.5 Main SMPS Protections

4.5.1 Overcurrent Protection

Main SMPS (Switched Mode Power Supply) transformer current of your **LINUS 5C** amplifier is continuously monitored. If over current occurs, the main SMPS immediately stops working. Should there be an internal failure, this feature prevents other parts being damaged.

4.5.2 Overload Protection

In case of extremely high output levels with heavily clipped output signals and low loudspeaker impedances $< 3 \Omega$, this additional protection will reduce the amplifier stage output current limitation very quickly. If activated, this indicates that the amplifier is running close to its absolute maximum power capacity. In normal operation (no clipping or only slight clipping) this protection should never be activated.

4.5.3 Thermal Protection

The temperature of the main SMPS transformer of your **LINUS 5C** amplifier is permanently monitored. If the temperature exceeds 85°C , the main SMPS is switched off. The amplifier's display will indicate a main SMPS error in this case.

4.6 Fans

The fans mounted in your **LINUS 5C** amplifier operate permanently, but as long as the temperature remains below 40°C , they run at their slowest speed and can hardly be heard. The highest detected temperature from either channel controls the speed of the fans. Above 40°C the speed is increased until it reaches its maximum value.

<p>Output Power 1 kHz, THD \leq 1%, in dual channel operation <small>typical values @ 230 V / 50 Hz duration limited by fuse / thermal protection for RL < 8 Ω.</small></p>	<p>400 W @ 8 Ω 700 W @ 4 Ω 1250 W @ 2 Ω</p>
<p>Peak Output Power 1 kHz, single sine wave in dual channel operation <small>typical values, may be subjected to component tolerances</small></p>	<p>900 W @ 8 Ω Peak 1600 W @ 4 Ω Peak 2800 W @ 2 Ω Peak</p>
<p>Circuitry</p>	<p>Class D</p>
<p>Signal to Noise-Ratio <small>22 Hz – 20 kHz, 4 Ω load</small></p>	<p>>105 dB (unweighted) >108 dB (A-weighted)</p>
<p>Power consumption @ 230 V <small>* both channels driven at 150 W output power (approx. 1/2 of max. THD limited output power with pink noise to represent typical music signal)</small></p>	<p>Amplifier standby (power off): 27 W Idle (Amp powered on): 115 W 4 Ω: 851 W *</p>
<p>Maximum output voltage <small>in dual channel operation; typical values, may be subjected to component tolerances</small></p>	<p>\pm 85 V peak</p>
<p>Maximum output current <small>in dual channel operation; typical values, may be subjected to component tolerances</small></p>	<p>\pm 38 A peak</p>

Frequency Response <small>@ 4 Ω load with 120 W output power</small>	35 Hz – 20 kHz: ± 1 dB
THD+N over frequency <small>@ 4 Ω load with 120 W output power</small>	20 Hz – 17 kHz: <0,1%
Damping Factor <small>8 Ω load, 1 kHz and below</small>	>400
Input Impedance	32 kΩ balanced
Input Gain	32 dB
Maximum Analogue Differential Input Level	+ 16 dBu / 4,89 Vrms / 8,70 Vp
Minimum Loudspeaker Load Impedance <small>lower values are safe, but out of specification no performance guarantees can be given when driving lower impedances than specified</small>	Zmin = 2 Ω for Dual-Channel operation
Protection Circuits	Inrush-current limitation, protection circuits against power on / off transients, temperature monitoring of transformers and heatsinks, output DC protection, intelligent mains fuse protection, SMPS overload protection, overcurrent limitation
Cooling	Two temperature dependent speed-controlled axial fans
LED Indicators	LEDs for Sensor, Protection, Limit, Signal, Ethernet
Input Connectors	Four 3-pin XLR female analogue input connectors, pin 2 = hot (inphase) Two analog network connectors (in and link) RJ45 Two AES/EBU connector RJ45 (in and link) One Ethernet RJ45
Power Output Connectors	Two 4-pole SPEAKON® connector, One 8-pole SPEAKON® connector
Modes of Operation	Quad channel
Input Sources	Analogue, AES/EBU
A/D – D/A Converters	24 bit / 96 kHz

We reserve the right to make technical alterations without prior notice

Latency

Min. 2,70 ms with DSP on and AES/EBU input
 Min. 2,00 ms with DSP on and analog input

Digital Inputs

AES / EBU, 32 – 196 kHz with sample rate converter

AC mains

*: Approximate mains voltage ranges where the amplifier can be used. Amplifier output power performance will decrease with lower mains voltages than the rated 230 V / 120 V and slightly increase with higher mains voltages.

Single-voltage PSU without automatic voltage range selection
 Either 230 V or 115 V, 50 - 60 Hz
 Operating voltages*: 230 V range: 180–264 V, 115 V range: 85–134 V
 Neutrik 32 A powerCON® connector

Operating Temperature

+5 °C to +55 °C

Dimensions (W × H × D)

483 × 88,1 × 452,5 mm / 19 × 3,5 × 17,2 inches (19", 2U)

Net Weight

10,7 kg / 23,6 lbs

Shipping Dimensions (W × H × D)

615 × 135 × 540 mm (0,045 m³) / 21,3 × 5,3 × 24,2 inches

Shipping Weight

13 kg / 28,7 lbs

We reserve the right to make technical alterations without prior notice

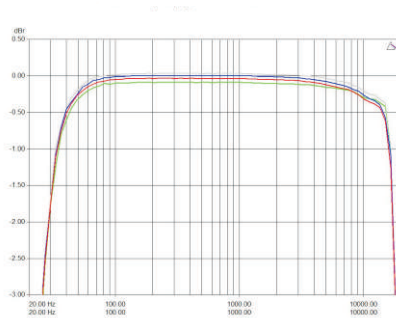

Figure 6.1

Freqsweep w/ AES17-filter @ 120 W output power, 4 Ω
(Measurement of a typical performance)

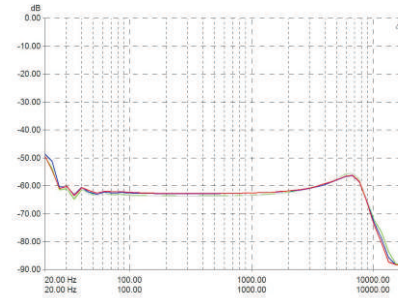

Figure 6.3

THD+N w/ AES17-filter @ 20 Hz \rightarrow 20 kHz, 120W output power, 4 Ω
(Measurement of a typical performance)

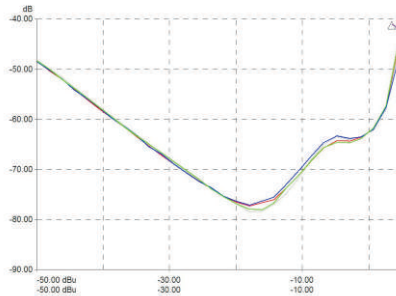

Figure 6.2

THD+N w/ AES17-filter @ -50dBu \rightarrow +10dBu, 4 Ω
(Measurement of a typical performance)

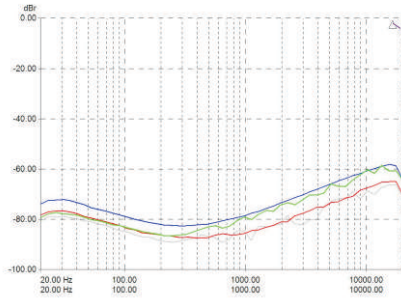

Figure 6.4
 C-sweep @ 20 Hz -> 20 kHz
 (Measurement of a typical performance)

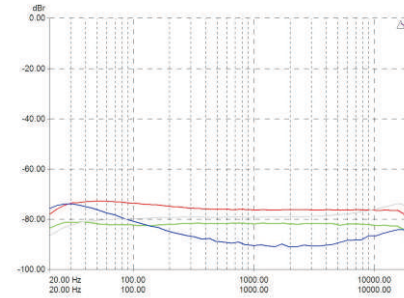

Figure 6.6
 CMSweep @ 20 Hz -> 20 kHz
 (Measurement of a typical performance)

7.1 Summary of Warranty

CODA AUDIO guarantees the **LINUS 5C** Amplifier to be free from defective material and/or workmanship for a period of six (6) years from the date of sale. When a defect occurs under normal installation and use, **CODA AUDIO** will repair the product under this warranty. In this event, please return the amplifier to your dealer/distributor together with a copy of your sales receipt as proof of purchase.

This warranty provides that examination of the returned product must indicate in our judgement a manufacturing defect.

7.2 Items Excluded from This Warranty

CODA AUDIO is not liable for any damage caused by shipping accidents, misuse, abuse, operation with incorrect AC voltage, operation with faulty peripheral equipment, modification or alteration without prior factory approval, service by an unauthorized service center and normal wear and tear. Amplifiers on which the serial number has been removed or defaced are not eligible for warranty service.

7.3 What **CODA AUDIO** Will Do

CODA AUDIO (or its appointed agent) undertakes to rectify any defect regardless of the reason for failure (unless excluded from this warranty), by repair, replacement or refund as it sees fit.

7.4 How to Obtain Warranty Service

You must notify your dealer/distributor of your need for warranty service. All components must be shipped in the original packaging.

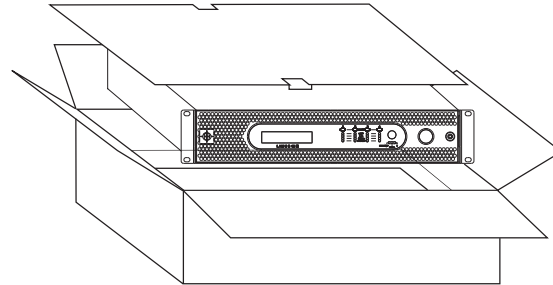

7.5 **CODA AUDIO**'s Product Improvement

CODA AUDIO reserves the right to improve the technical standard of its products without giving prior notice. If in any doubt, please consult your dealer/distributor or contact **CODA AUDIO** directly for clarification.

PLEASE ENCLOSE THIS COMPLETED FORM WITH THE AMPLIFIER DO NOT SEND SEPARATELY

Owner's Information

Company Name: _____

Contact: _____

Address: _____

Telephone: _____

Facsimile: _____

eMail Address: _____

Model: _____

Serial Number: _____

Purchase Date: _____

Nature of problem occurred

Please describe the conditions that existed when the problem occurred and what attempts were made to correct it: _____

Expired Warranty

If the warranty has expired, payment will be:

Cash/Cheque

VISA

MasterCard

Other equipment in your system: _____

Shipping Address

To transport the amplifier, the original packing materials must be used.

Please return the amplifier to the following address or your nearest

CODA AUDIO appointed distributor.

Our web site: www.codaudio.com provides a complete list of **CODA AUDIO** dealers/distributors.



CODA AUDIO GmbH, Boulevard der EU 6, 30539 Hannover, Germany

9 Maintenance Information

Cleaning and servicing the inside of the amplifier must never be carried out by unqualified personnel. The amplifier must never be opened by unqualified personnel.

Cleaning and servicing work on the inside of the amplifier must only be carried out by qualified personnel.

Qualified personnel is defined as a person who has gained specialised relevant knowledge of electronic engineering through education, training, and experience, and who has sufficient knowledge of all relevant governmental work safety regulations to be in a position to judge the safe functioning of power amplifiers based on technical rules according to IEC 60065 (IEC 60065 (DIN EN 60065) "Safety Requirements for Audio, Video or similar Electronic Appliances").

In order to guarantee the safe functioning of the amplifier, it has to be checked regularly, depending on its application but at least once a year, by a properly qualified person.

Advice on how to carry out these checks can be found in DIN VDE 0702-1 "Safety Checks for Electronic Appliances".

An amplifier that is considered to be unsafe must be labelled accordingly and stored in a safe place to prevent this amplifier being used mistakenly.

10 Decommissioning

During the decommissioning process of the amplifier, all legally prescribed rules and procedures must be adhered to.

Mailing Address:
CODA AUDIO GmbH
Boulevard der EU 6
30539 Hannover
Germany

Telephone:
+49 (0) 511 86655888

Facsimile:
+49 (0) 511 86655887

Internet:
www.codaaudio.com

Email:
contact@codaaudioaudio.com

