

# eurolite®

USER MANUAL

WiFi (( ))



No. 50531112

LED Strip RGB WiFi Controller



## 1. Introduction

Thank you for purchasing this LED controller designed for control of LED strips requiring an operating voltage of 12 V and 24 V direct current. An iOS or Android app can be used to control the LEDs by means of a smartphone. The apps are available free of charge from the app stores.

The maximum power consumption of a color must not exceed 4 A and of all LEDs connected 12 A. The connection must be made by skilled personnel only. Please read these operating instructions carefully before using the product. They contain important information for the correct use of your product. Please keep them for future reference.

## 2. App installation

Download and install the FreeColor app.



Android App



iOS App

## 3. Safety Instructions

- Only use the product according to the instructions given herein. Damages due to failure to follow these operating instructions will void the warranty! We do not assume any liability for any resulting damage.
- We do not assume any liability for material and personal damage caused by improper use or non-compliance with the safety instructions. In such cases, the warranty/guarantee will be null and void.
- Unauthorized rebuilds or modifications of the product are not permitted for reasons of safety and render the warranty invalid.
- This product is not a toy. Keep it out of the reach of children. Do not leave packaging material lying around carelessly.
- Keep this device away from rain and moisture. Indoor use only.
- Protect the product against excessive humidity and heat. The recommended temperature is -5 to +45°C.
- Before taking into operation, check upon possible damages. If defective, the product must not be taken into operation.
- This product is maintenance-free, except for occasional cleaning. You can use a slightly dampened cloth for cleaning. Never use alcohol or solvents.
- Maintenance and service operations are only to be carried out by authorized dealers.



### Disposal of old equipment

When to be definitively put out of operation, take the product to a local Recycling plant. Do not dispose of as household waste!

## 4. Connections

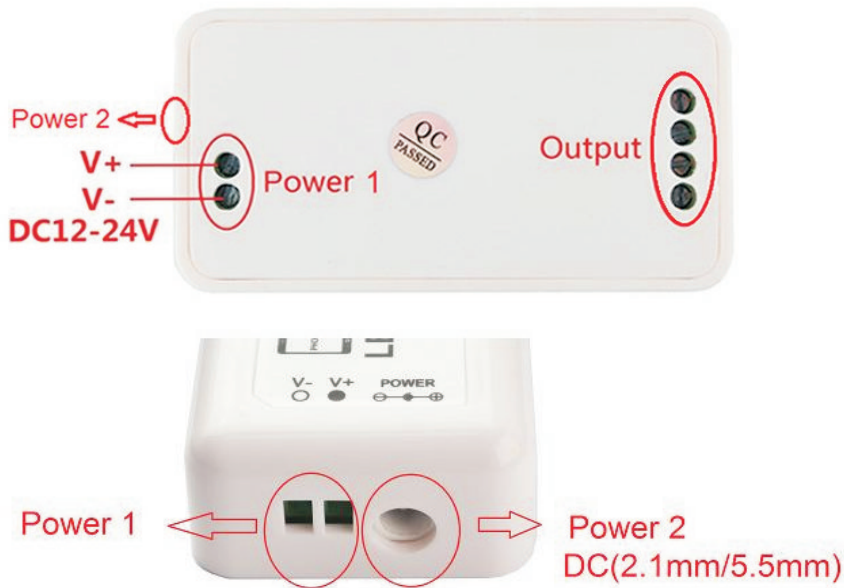

1. Connect the LEDs to the screw terminals R, G, B (negative poles), V+ (common positive pole). The load by the LEDs must not exceed 4 A per channel. The total load must not exceed 12 A; otherwise the controller will be damaged.
2. For power supply, connect a regulated power supply unit (min. 12 V, max. 24 V) to the positive and negative terminals V+ and V- or the POWER jack. Thus, the controller is switched on.

### Connection example 1: RGB LEDs

CH3: B, CH2: G, CH1: R, V+: COM

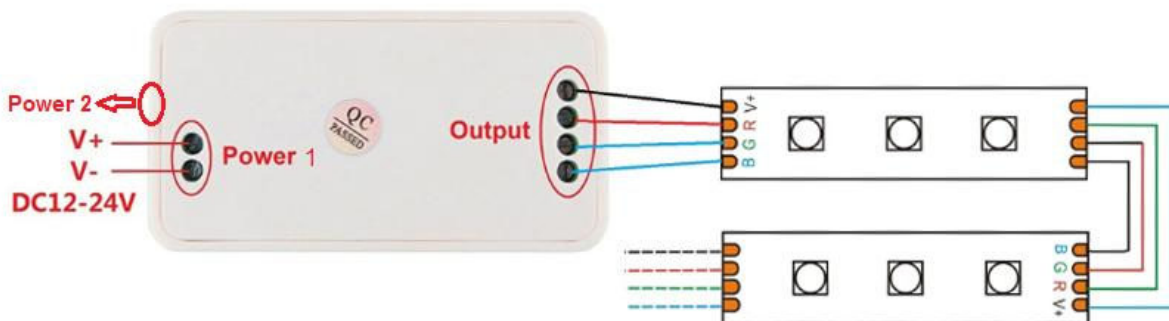

### Connection example 2: white LEDs with variable color temperature (CT)

G: CW, R: WW, V+: COM

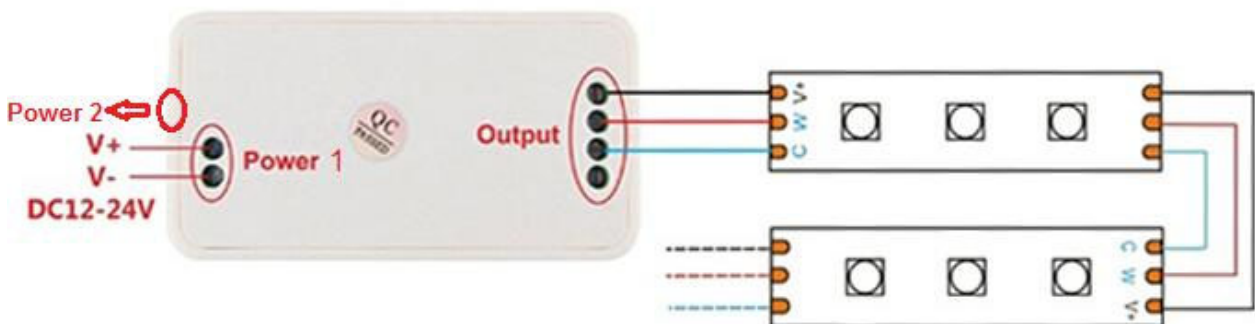

### Connection example 3: single-colored LEDs (DIM)

R: V-, G: V-, B: V-, V+: V+

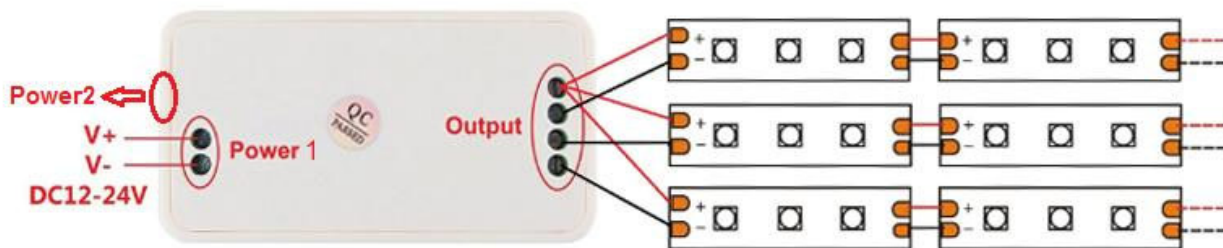

### 5. Direct connection to an Android/iOS device (AP mode)

When establishing a connection for the first time, the controller can only be directly connected to one smartphone (access point mode). The station mode allows for connection to a Wi-Fi network.

- Step 1:** Call the settings menu on your Android or iOS device and establish a connection with the network **HX001** (default name).
- Step 2:** Open the application **FreeColor** and pick **HX001** from the list. The app automatically searches for the controller. If the controller does not appear on the device list, however, tap the button in the upper right corner to repeat the search.
- Step 3:** Pick your controller from the list and tap on the color wheel to enter the color settings.

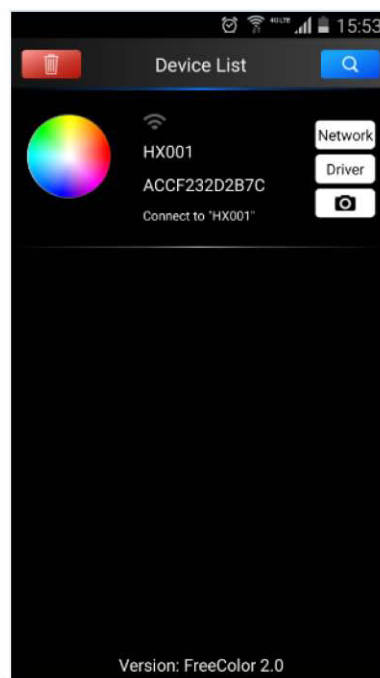
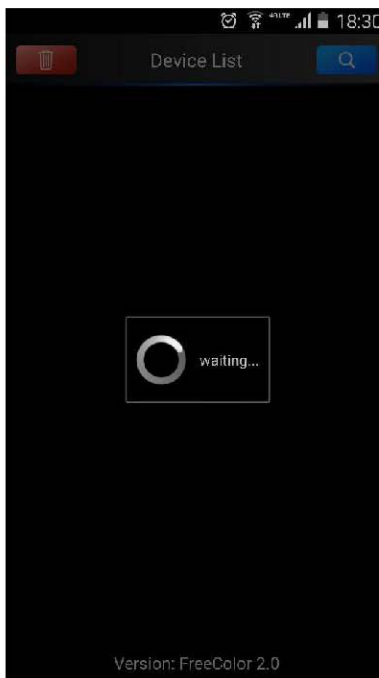

## 6. Connection to a Wi-Fi network (STA mode)

**Step 1:** First, connect the controller to your smartphone as described above.

**Step 2:** Select the menu item “**Network**”.

**Step 3:** Now select “**Connect to existing LAN**”. The controller now automatically searches for available networks.

**Step 4:** Pick the desired network from the list. You are now asked to enter the network’s SSID password. Enter the password and confirm with “**OK**”. If the connection has been successfully established, the display indicates “**change wifi success and search again**”.

**Step 5:** The controller now automatically goes back to the device list. Tap on the color wheel to enter the color settings

**Note:** The Wi-Fi connection can only be reversed by resetting the controller. For this, open the housing and press the red button for 6 seconds. The controller is now reset to AP mode.

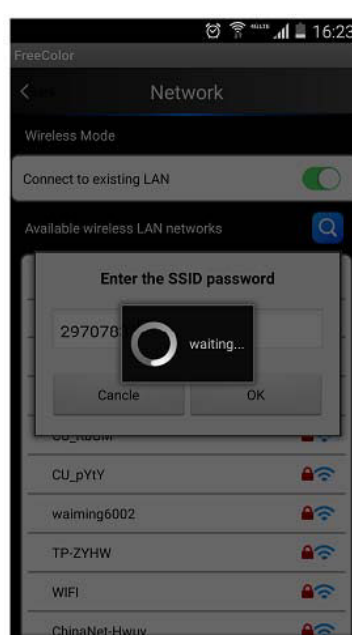
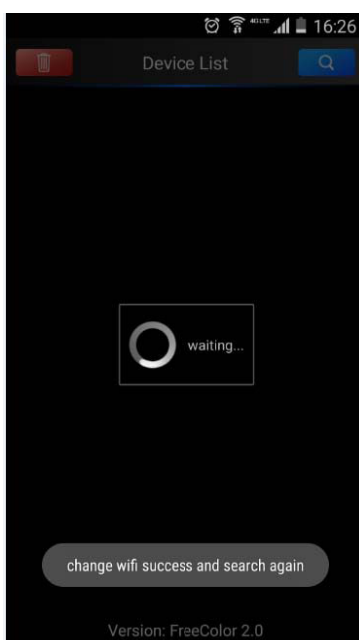
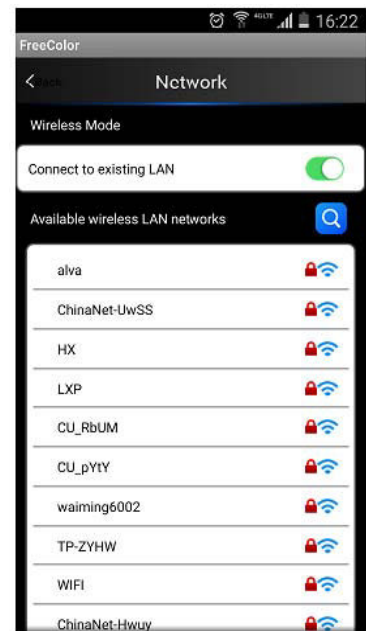
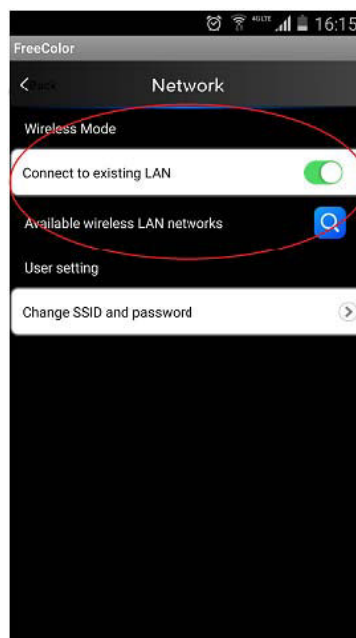
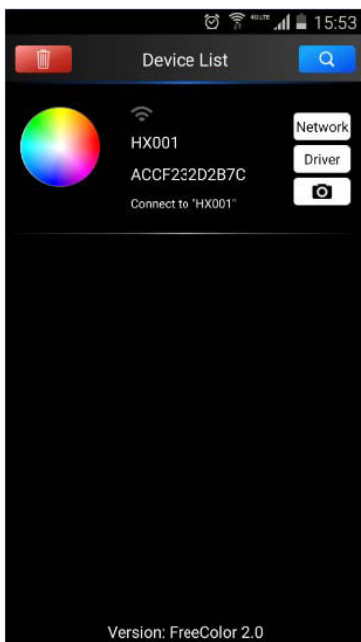

## 7. Resetting SSID and password

The device name (SSID) and password can be changed, e.g. to distinguish between several devices.

**Step 1:** Call the device list, click on “**Network**” and select “**Change SSID and password**”.

**Step 2:** You can now enter a new SSID (max. 99 characters) and a new password.

**Step 3:** Confirm with “**apply**”.

**Step 4:** Reconnect the device to the network.

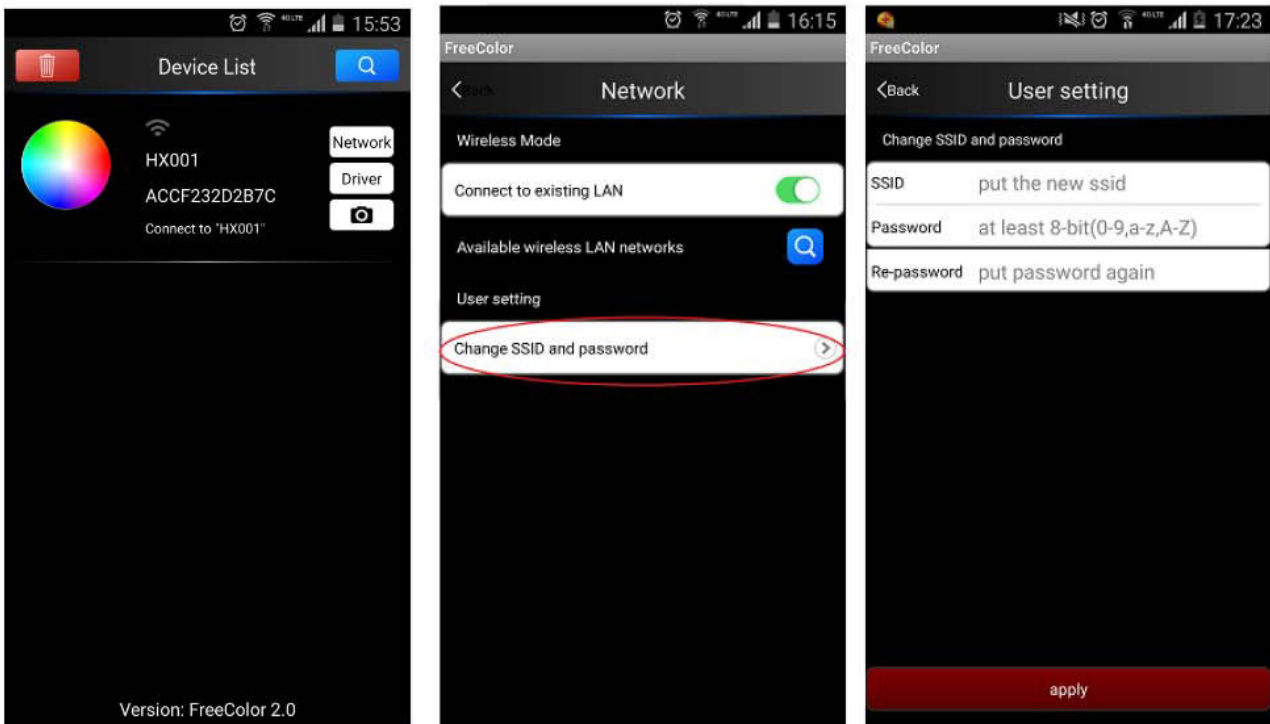

## 8. Using the FreeColor app

FreeColor is a 3-in-1 app with RGB, CT and dimmer function. The controller is set to RGB mode by default. Click on “**Driver**” to change the mode.

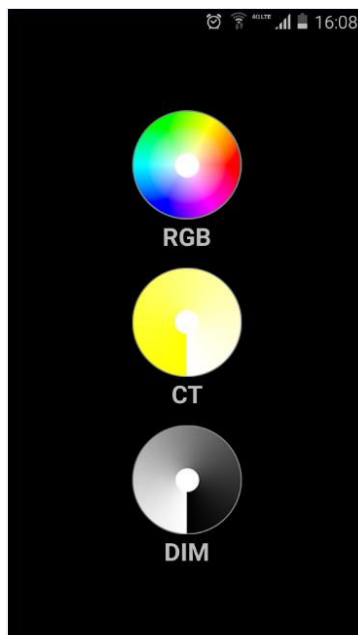

The main control interface of the 3 different modes looks like this:

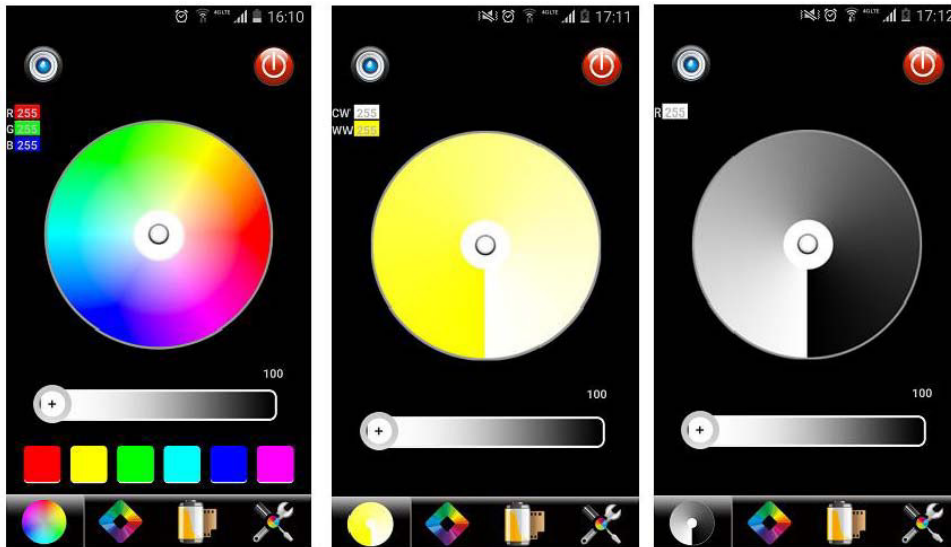

### Main control interface

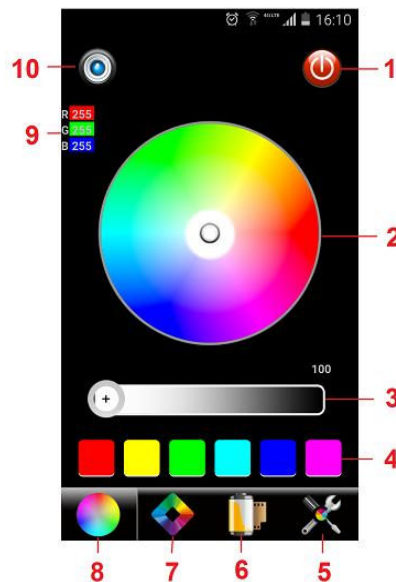

No.	Button	Function
1	On/Off	Turn LEDs on/off
2	Color wheel	Select any static color from color wheel
3	Brightness fader	Adjust brightness 0-100 %
4	Color presets	Quickly select 6 colors
5	System settings	Call the device list, establish WiFi connection, select operation mode (RGB, CT or Dimmer)
6	DIY mode	Call DIY mode and display manually created effects
7	Dynamic modes	Select dynamic modes e.g. color fade, strobe effect
8	RGB color wheel	Display the RGB color wheel
9	Color value	Display the R/G/B gray value; L: current brightness level
10	DIY saving button	To save colors or effects created in DIY mode

## Dynamic mode interface

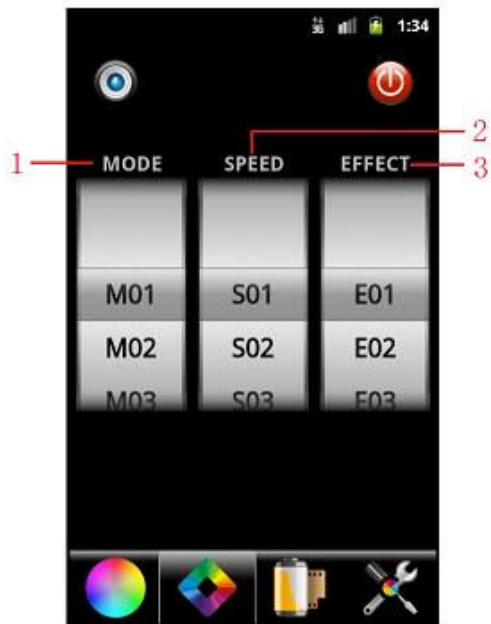

**MODE:** To select dynamic effect, e.g. strobe or color fade

**SPEED:** To adjust the running speed of the effect

**EFFECT:** Make adjustments to the selected effect

## DIY mode interface



On this page, you see your DIY effects. Up to 12 effects can be stored here.

Push the saving button in order to save an effect and the DIY button to call your stored effects.

## 9. Technical Specifications

Power supply:	12-24 V DC
Power consumption:	<3 W
Output power:	max. 144 W (12 V), 288 W (24 V)
Output current:	max. 4 A per channel (12 A total)
Carrier frequency:	2.4 GHz
App required	FreeColor
Dimensions (L x W x H):	86 x 45 x 23 mm
Weight:	40 g

Subject to change.

Steinigke Showtechnic GmbH Andreas-Bauer-Str. 5 97297 Waldbüttelbrunn Germany