

DTW BLINDER 700 IP™

user manual

©2016 **ELATION PROFESSIONAL** all rights reserved. Information, specifications, diagrams, images, and instructions herein are subject to change without notice. ELATION PROFESSIONAL logo and identifying product names and numbers herein are trademarks of ELATION PROFESSIONAL. Copyright protection claimed includes all forms and matters of copyrightable materials and information now allowed by statutory or judicial law or hereinafter granted. Product names used in this document may be trademarks or registered trademarks of their respective companies and are hereby acknowledged. All non-ELATION brands and product names are trademarks or registered trademarks of their respective companies.

ELATION PROFESSIONAL and all affiliated companies hereby disclaim any and all liabilities for property, equipment, building, and electrical damages, injuries to any persons, and direct or indirect economic loss associated with the use or reliance of any information contained within this document, and/or as a result of the improper, unsafe, insufficient and negligent assembly, installation, rigging, and operation of this product.

Elation Professional USA | 6122 S. Eastern Ave. | Los Angeles, CA. 90040

323-582-3322 | 323-832-9142 fax | www.elationlighting.com | info@elationlighting.com

Elation Professional B.V. | Junostraat 2 | 6468 EW Kerkrade, The Netherlands

+31 45 546 85 66 | +31 45 546 85 96 fax | www.elationlighting.eu | info@elationlighting.eu

DOCUMENT VERSION



Please check www.elationlighting.com for the latest revision/update of this manual.

Date	Document Version	Software Version	DMX Channel Modes	Notes
09/26/16	1	≥V1.02	01CH, 02CH, 04CH1, 04CH 05CH, 06CH1, 07CH, 09CH, 13CH	Initial release.

CONTENTS

General Information	4
Warranty	7
Safety Instructions and Guidelines	8
Overview	10
Installation	11
System Menu	15
DMX Channel Functions And Values	18
Cleaning and Maintenance	20
Technical Specifications	21
Optional Accessories	23

GENERAL INFORMATION

INTRODUCTION

Congratulations, you have just purchased one of the most innovative and reliable IP65 rated lighting fixtures on the market today! This fixture has been designed to perform reliably for years when the guidelines in this booklet are followed. Please read and understand the instructions in this manual carefully and thoroughly before attempting to operate this unit. These instructions contain important information regarding safety during use and maintenance.



IP65 RATED

An IP rated lighting fixture is one, which is commonly installed in outdoor environments and has been designed with an enclosure that effectively protects the ingress (entry) of external foreign objects such as dust and water. The **International Protection (IP)** rating system is commonly expressed as "IP" (Ingress Protection) followed by two numbers (i.e. IP65) where the numbers define the degree of protection. The first digit (Foreign Bodies Protection) indicates the extent of protection against particles entering the fixture and the second digit (Water Protection) indicates the extent of protection against water entering the fixture. An IP65 rated lighting fixture is one, which has been designed and tested to protect against the ingress of dust (6) and high-pressure water jets from any direction (5).



MARINE / COASTAL ENVIRONMENT INSTALLATIONS!

Please note although this fixture is IP rated, the fixture is **NOT** suitable for marine and/or coastal environment installations. Installing this fixture in a marine and/or coastal environment may cause corrosion and/or excessive wear to the interior and/or exterior components of the fixture. Damages and/or performance issues resulting from installation in a marine and/or coastal environment will void the manufacturer's warranty and will **NOT** be subject to any warranty claims and/or repairs.



ENSURE ALL CONNECTIONS AND END CAPS ARE PROPERLY SEALED WITH A NON-CONDUCTIVE DIELECTRIC GREASE (AVAILABLE AT MOST ELECTRICAL SUPPLIERS) TO PREVENT WATER INGRESS/CONDENSATION AND/OR CORROSION.



OPTIONAL CORROSION-RESISTANT COATING

Optional Corrosion-Resistant Coatings may be available for this fixture. Please consult your **Elation Professional** sales representative for details.

UNPACKING

Every fixture has been thoroughly tested and has been shipped in perfect operating condition. Carefully check the shipping carton for damage that may have occurred during shipping. If the carton appears to be damaged, carefully inspect your unit for damage and be sure all accessories necessary to operate the unit have arrived intact. In the event damage has been found or parts are missing, please contact our customer support team for further instructions. Please do not return this unit to your dealer without first contacting customer support at the number listed below. Please do not discard the shipping carton in the trash. Please recycle whenever possible.

BOX CONTENTS

- (1) powerCON TRUE1 Cable
- (4) Removable 25° Narrow Beam Fresnel Lens (Installed)

CUSTOMER SUPPORT

Elation Professional® provides a customer support line, to provide set up help and to answer any question should you encounter problems during your set up or initial operation. You may also visit us on the web at www.elationlighting.com for any comments or suggestions. For service related issue please contact Elation Professional®.

ELATION SERVICE USA - Monday - Friday 8:00am to 5:00pm PST

Voice: 323-582-3322

Fax: 323-832-9142

E-mail: support@elationlighting.com

ELATION SERVICE EUROPE - Monday - Friday 08:30 to 17:00 CET

Voice: +31 45 546 85 30

Fax: +31 45 546 85 96

E-mail: support@elationlighting.eu

WARRANTY REGISTRATION

Please complete and mail in the enclosed warranty card or register online: <http://www.elationlighting.com/Login.aspx> to validate your purchase. All returned service items whether under warranty or not, must be freight pre-paid and accompany a return authorization (R.A.) number. The R.A. number must be clearly written on the outside of the return package. A brief description of the problem as well as the R.A. number must also be written down on a piece of paper and included in the shipping container. If the unit is under warranty, you must provide a copy of your proof of purchase invoice. Items returned without a R.A. number clearly marked on the outside of the package will be refused and returned at customer's expense. You may obtain a R.A. number by contacting customer support.



IMPORTANT NOTICE!

There are no user serviceable parts inside this unit. Do not attempt any repairs yourself; doing so will void your manufactures warranty. Damages resulting from modifications to this fixture and/or the disregard of safety and general user instructions found in this user manual void the manufactures warranty and are not subject to any warranty claims and/or repairs.

LIMITED WARRANTY

A. Elation Professional® hereby warrants, to the original purchaser, Elation Professional® products to be free of manufacturing defects in material and workmanship for a period of two years (730 days), and Elation Professional® product rechargeable batteries to be free of manufacturing defects in material and workmanship for a period of six months (180 days), from the original date of purchase. This warranty excludes discharge lamps and all product accessories. This warranty shall be valid only if the product is purchased within the United States of America, including possessions and territories. It is the owner's responsibility to establish the date and place of purchase by acceptable evidence, at the time service is sought.

B. For warranty service, send the product only to the Elation Professional® factory. All shipping charges must be pre-paid. If the requested repairs or service (including parts replacement) are within the terms of this warranty, Elation Professional® will pay return shipping charges only to a designated point within the United States. If any product is sent, it must be shipped in its original package and packaging material. No accessories should be shipped with the product. If any accessories are shipped with the product, Elation Professional® shall have no liability what so ever for loss and/or or damage to any such accessories, nor for the safe return thereof.

C. This warranty is void if the product serial number and/or labels are altered or removed; if the product is modified in any manner which Elation Professional® concludes, after inspection, affects the reliability of the product; if the product has been repaired or serviced by anyone other than the Elation Professional® factory unless prior written authorization was issued to purchaser by Elation Professional®; if the product is damaged because not properly maintained as set forth in the product instructions, guidelines and/or user manual.

D. This is not a service contract, and this warranty does not include any maintenance, cleaning or periodic check-up. During the periods as specified above, Elation Professional® will replace defective parts at its expense, and will absorb all expenses for warranty service and repair labor by reason of defects in material or workmanship. The sole responsibility of Elation Professional® under this warranty shall be limited to the repair of the product, or replacement thereof, including parts, at the sole discretion of Elation Professional®. All products covered by this warranty were manufactured after January 1, 1990, and bare identifying marks to that effect.

E. Elation Professional® reserves the right to make changes in design and/or performance improvements upon its products without any obligation to include these changes in any products theretofore manufactured.

F. No warranty, whether expressed or implied, is given or made with respect to any accessory supplied with the products described above. Except to the extent prohibited by applicable law, all implied warranties made by Elation Professional® in connection with this product, including warranties of merchantability or fitness, are limited in duration to the warranty periods set forth above. And no warranties, whether expressed or implied, including warranties of merchantability or fitness, shall apply to this product after said periods have expired. The consumer's and/or dealer's sole remedy shall be such repair or replacement as is expressly provided above; and under no circumstances shall Elation Professional® be liable for any loss and/or damage, direct and/or consequential, arising out of the use of, and/or the inability to use, this product.

G. This warranty is the only written warranty applicable to Elation Professional® products and supersedes all prior warranties and written descriptions of warranty terms and conditions heretofore published.

SAFETY INSTRUCTIONS AND GUIDELINES

This fixture is an extremely sophisticated piece of electronic equipment. To guarantee a smooth operation, it is important to follow all instructions and guidelines in this manual. The manufacturer of this device is not responsible for injury and/or damages resulting from the misuse of this fixture due to the disregard of the information printed in this manual. Only qualified and/or certified personnel should perform installation of this fixture and only the original rigging parts (omega brackets) included with this fixture should be used for installation. Any modifications to the fixture and/or the mounting hardware included will void the original manufacturer's warranty and increase the risk of damage and/or personal injury.



PROTECTION CLASS 1 - FIXTURE MUST BE PROPERLY GROUNDED

DO NOT PLUG FIXTURE INTO A DIMMER PACK!



NEVER OPEN THIS FIXTURE WHILE IN USE!

UNPLUG POWER BEFORE SERVICING FIXTURE!

NEVER TOUCH FIXTURE DURING OPERATION, AS IT MAY BE HOT!

KEEP FLAMMABLE MATERIALS AWAY FROM FIXTURE!



NEVER LOOK DIRECTLY INTO THE LIGHT SOURCE!

RETINA INJURY RISK - MAY INDUCE BLINDNESS!

SENSITIVE PERSONS MAY SUFFER AN EPILEPTIC SHOCK!



ENSURE ALL CONNECTIONS AND END CAPS ARE PROPERLY SEALED WITH A DIELECTRIC GREASE (AVAILABLE AT MOST ELECTRICAL SUPPLIERS) TO PREVENT WATER CORROSION AND/OR ELECTRICAL SHORT CIRCUIT.

SAFETY INSTRUCTIONS AND GUIDELINES

- **DO NOT TOUCH** the fixture housing during operation. Turn OFF the power and allow approximately 15 minutes for the fixture to cool down before serving.
- **DO NOT** shake fixture, avoid brute force when installing and/or operating fixture.
- **DO NOT** operate fixture if the power cord has become frayed, crimped and/or damaged. If the power cord is damaged, replace it immediately with a new one of similar power rating.
- **DO NOT** block any air ventilation slots. All fan and air inlets must remain clean and never blocked. Allow approx. 6" (15cm) between fixture and other devices or a wall for proper cooling.
- When installing fixture in a suspended environment, always use mounting hardware that is no less than M10 x 25 mm, and always install fixture with an appropriately rated safety cable.
- Always disconnect fixture from main power source before performing any type of service and/or cleaning procedure. Only handle the power cord by the plug end, never pull out the plug by tugging the wire portion of the cord.
- During the initial operation of this fixture, a light smoke or smell may emit from the interior of the fixture. This is a normal process and is caused by excess paint in the interior of the casing burning off from the heat associated with the lamp and will decrease gradually over time.
- Consistent operational breaks will ensure the fixture will function properly for many years to come.
- Use the original packaging and materials to transport the fixture in for service.

OVERVIEW

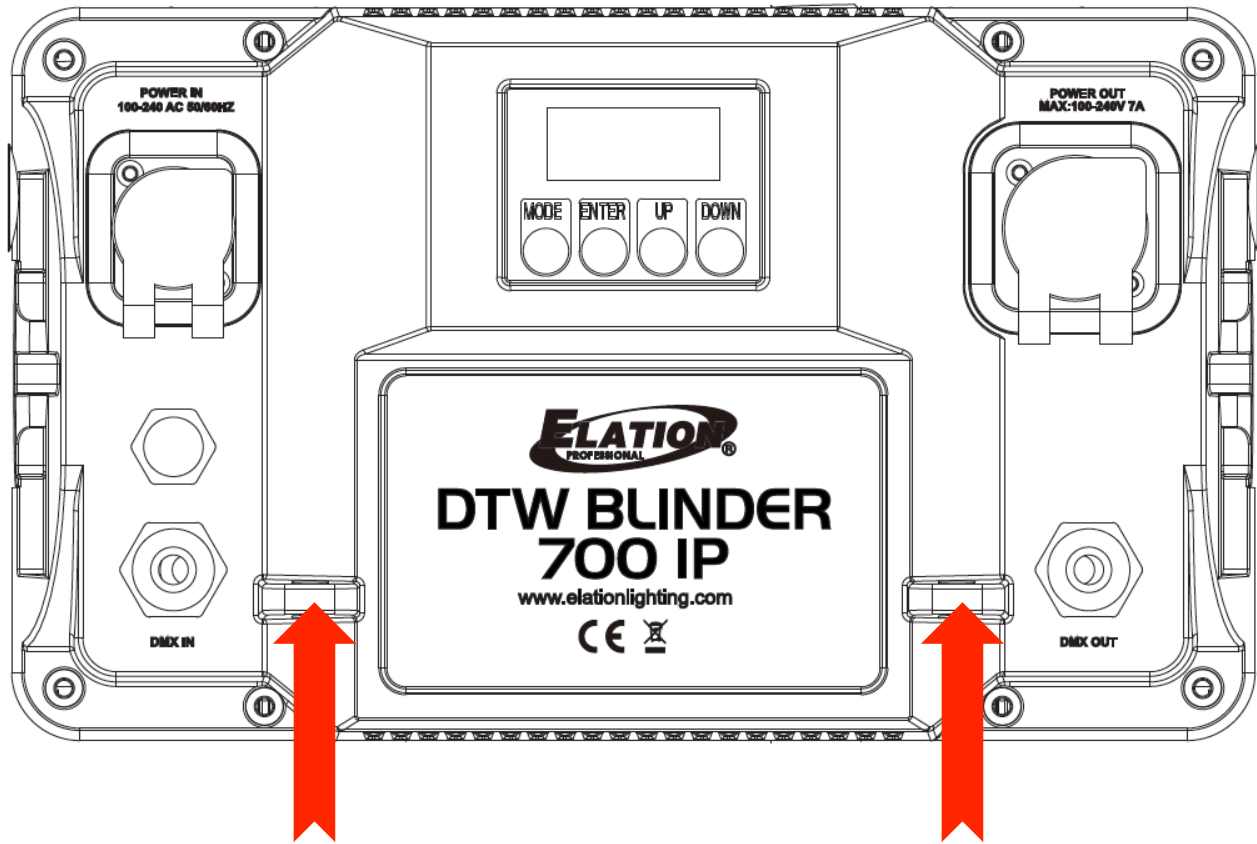

SAFETY CABLE RIGGING POINTS

INSTALLATION



FLAMMABLE MATERIAL WARNING

Keep fixture at least 5.0 ft (1.5m) away from any flammable materials, decorations, pyrotechnics, etc.



ELECTRICAL CONNECTIONS

A qualified electrician should be used for all electrical connections and/or installations.

CAUTIONS



ENSURE ALL CONNECTIONS AND END CAPS ARE PROPERLY SEALED WITH A DIELECTRIC GREASE (AVAILABLE AT MOST ELECTRICAL SUPPLIERS) TO PREVENT WATER CORROSION AND/OR ELECTRICAL SHORT CIRCUIT.

- For added protection, mount the fixture in areas outside walking paths, seating areas, or in areas where unauthorized personnel might reach the fixture.
- Ambient operating temperature range for this fixture is **5° to 113°F. (-15° to 45°C)**
Do not use the fixture under or above this temperature.
- Before mounting the fixture to any surface, make sure the installation area can hold a minimum point load of 10 times the weight of the fixture.
- Fixture installation must always be secured with a secondary safety attachment, such as an appropriate safety cable.
- Never stand directly below the device when mounting, removing or servicing.

CLAMP INSTALLATION

The fixture provides an integrated mounting bracket / yoke. When mounting this fixture to truss be sure to secure an appropriately rated clamp to the mounting bracket / yoke using a M10 screw fitted through the center hole. Be sure to attach an appropriate **Safety Cable** (not included) to the fixture using the safety cable rigging point integrated into the back of the fixture.

RIGGING

Overhead rigging requires extensive experience, including amongst others calculating working load limits, installation material being used, and periodic safety inspection of all installation material and the fixture. If you lack these qualifications, do not attempt the installation yourself. Improper installation can result in bodily injury. Fixture is fully operational in the specific mounting positions illustrated below.

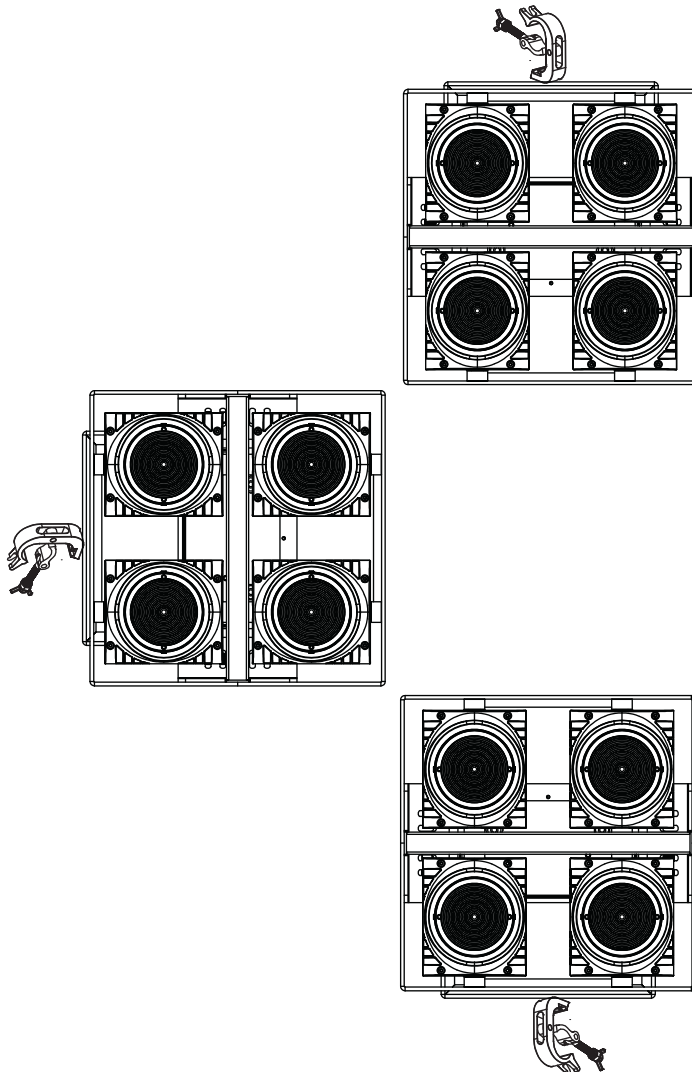

S A F E T Y C A B L E

**ALWAYS USE A SAFETY CABLE
WHENEVER INSTALLING THIS FIXTURE
IN A SUSPENDED ENVIRONMENT TO
ENSURE THE FIXTURE WILL NOT DROP
IF THE CLAMP FAILS.**

25° NARROW BEAM FRESNEL FILTER INSTALLATION

1. Hold lens filter in front of the COB module so that both small black raised plastic tabs are positioned horizontal at 9 and 3 o'clock. (See image below left)
2. Insert lens into COB module. (See image below right)

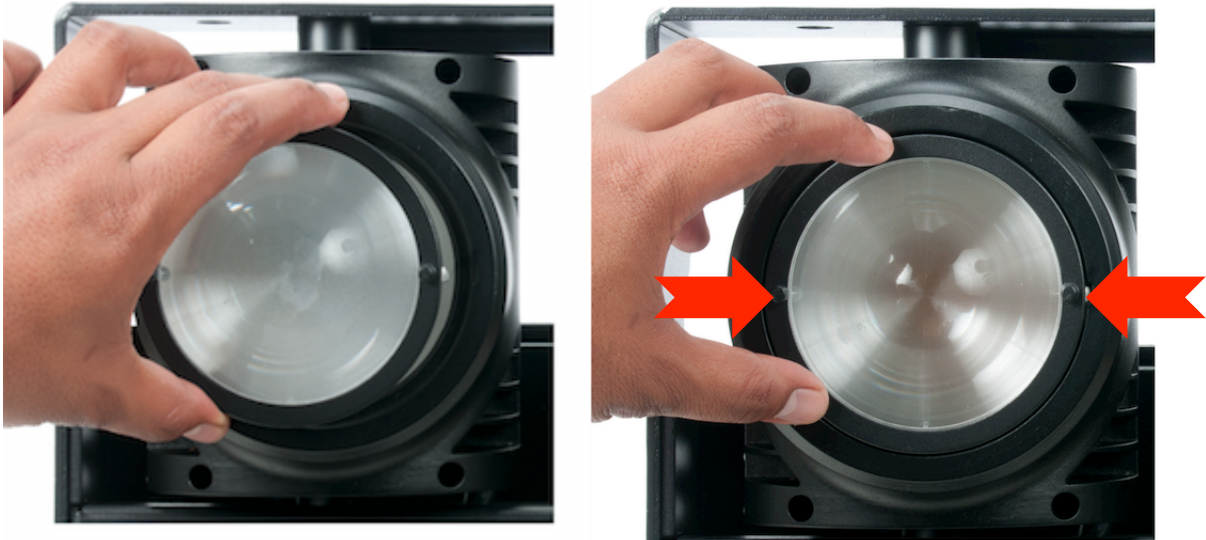

3. While applying gentle pressure against the lens, slowly turn the lens counter-clockwise a $\frac{1}{4}$ turn, until both small black raised plastic tabs are positioned vertical at 12 and 6 o'clock. (See image below)



ENSURE ALL LEN FILTERS ARE SECURELY INSTALLED AS ILLUSTRATED ABOVE BEFORE THE FIXTURE IS INSTALLED ON TRUSS AND/OR RIGGING.

POWER LINKING

Max number of **DTW BLINDER 700 IP™** units power linked together:

1 units @120V | 2 units @240V



**NOTE: USE CAUTION WHEN POWER LINKING OTHER FIXTURES TO DTW BLINDER 700 IP™!
POWER CONSUMPTION OF OTHER LIGHTING FIXTURES WILL VARY!
ALWAYS CHECK MAX AMP OUT RATING PRINTED ON THE REAR CONNECTION PANEL!**

SYSTEM MENU

The fixture comes with an easy to navigate system menu. The control panel (see image below) located on the front the fixture provides access to the main system menu and is where all necessary system adjustments are made to the fixture. During normal operation, pressing **MODE** button once will access the fixture's main menu. Once in the main menu you can navigate through the different functions and access the sub-menus with the **UP** and **DOWN** buttons. Once you reach a field that requires adjusting, press the **ENTER** button to activate that field and use the **UP** and **DOWN** buttons to adjust the field. Pressing the **ENTER** button once more will confirm your setting. You may exit the main menu at any time without making any adjustments by pressing the **MODE/ESC** button.

LCD CONTROL PANEL LOCKOUT FEATURE

When the **AUTO LOCK** menu is set to **ON** (default setting); the LCD control panel display will turn OFF and become LOCKED after non-use. To UNLOCK, press the **ENTER** button followed by pressing and holding the **MODE** button until the LCD control panel display is UNLOCKED.

When the **AUTO LOCK** menu is set to **ON1** and is LOCKED, follow these steps to UNLOCK:

1. When locked, the display will show: **LOCKED*******
2. Press **UP**, then the display will change to: **LOCKED****** (one * disappears)
3. Press **DOWN**, then the display will change to: **LOCKED***** (two * disappear)
4. Press **UP**, then the display will change to: **LOCKED**** (three * disappear)
5. Press **DOWN**, then the display will change to: **LOCKED*** (4 * disappear)
6. Press **ENTER**, then the display will change to **LOCKED** and then become unlocked.

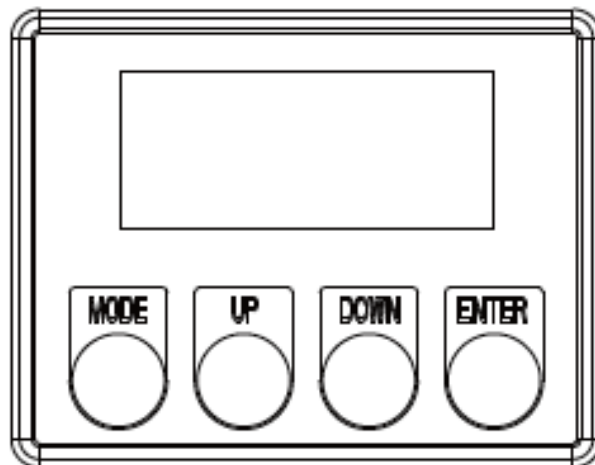

INFORMATION DISPLAYED DURING INITIAL POWER ON

When the fixture is initially powered ON, the display shows the following information:

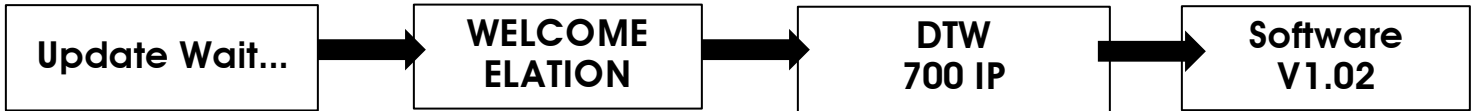

ELATION© DTW BLINDER 700 IP™ SYSTEM MENU			
Features are subject to change without any prior written notice.			
MAIN MENU	SUB MENU OPTIONS / VALUES (Default Settings in BOLD)		DESCRIPTION
DMX ADDR	001 ~ 512		Set the DMX Address
DMX Mode	01CH, 02CH, 04CH1, 04CH 05CH, 06CH1, 07CH, 09CH, 13CH		Set DMX Channel / User Mode
SLAVE MODE			Slave Mode
STATIC	Dim	000 - 255	Set Manual Dimmer Value
	Flash	000 - 255	Set Manual Strobe Value
	WW	000 - 255	Set Manual Warm White Value
	Amber	000 - 255	Set Manual Amber Value
FADING	SPEED:	00 - 99	Set Fading Program Speed
	FLASH	000 - 255	Set Fading Program Flash Rate
DIMMER	Standard , Stage, TV, Architec, Theatre		Set Dimmer Curve Mode
WhiteBal	WW1:	055 - 255	Set WW Balance Value for Pixel #1
	A1:	055 - 255	Set Amber Balance Value for Pixel #1
	WW2:	055 - 255	Set WW Balance Value for Pixel #2
	A2:	055 - 255	Set Amber Balance Value for Pixel #2
	WW3:	055 - 255	Set WW Balance Value for Pixel #3
	A3:	055 - 255	Set Amber Balance Value for Pixel #3
	WW4:	055 - 255	Set WW Balance Value for Pixel #4
	A4:	055 - 255	Set Amber Balance Value for Pixel #4
NO DMX	Hold / Blackout		Function If NO DMX Detected
AUTOLOCK	ON / ON1 / OFF		Control Front Panel Buttons Key Lock
Gamma	2.0 , 2.3, 2.4, 2.6, 2.8		Set GAMMA Brightness Value
TempUnit	F , °C		Temperature Display F/ C°
SYSTEM TEMP	L1	XXX F / C°	Displays Temperature of LED #1
	L2	XXX F / C°	Displays Temperature of LED #2
	L3	XXX F / C°	Displays Temperature of LED #3
	L4	XXX F / C°	Displays Temperature of LED #4
Default	OFF / ON		Restore Factory Settings

DIMMER

Select desired DIMMER MODE (**Standard**, Stage, TV, Architectural, Theatre).

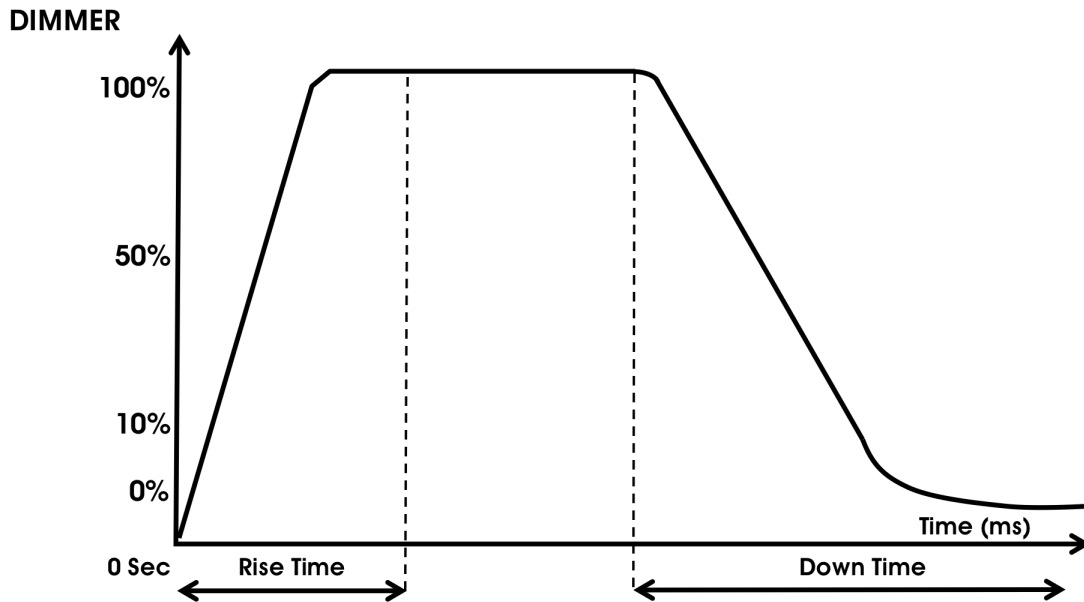

Dimming Curve Ramp Effect	0 sec Fade Time		1 sec Fade Time	
	Rise Time (ms)	Down Time (ms)	Rise Time (ms)	Down Time (ms)
Standard (default)	0	0	0	0
Stage	780	1100	1540	1660
TV	1180	1520	1860	1940
Architectural	1380	1730	2040	2120
Theatre	1580	1940	2230	2280

DMX CHANNEL FUNCTIONS AND VALUES

ELATION© DTW BLINDER 700 IP™

DMX Channel Values / Functions (13 Total Channels)

Features are subject to change without any prior written notice.

*Control of PIXELS depends on the fixture installation orientation.

DMX CHANNEL MODE									VALUE	FUNCTION
01CH	02CH	04CH1	04CH	05CH	06CH1	07CH	09CH	13CH		
	1		1	1	1	1			0-255	WARM WHITE - All PIXELS Cool White (0=Black - 255=100%)
	2		2	2	2	2			0-255	AMBER - All PIXELS Warm White (0=Black - 255=100%)
							1	1	0-255	WARM WHITE - PIXEL #1 Cool White (0=Black - 255=100%)
							2	2	0-255	AMBER - PIXEL #1 Warm White (0=Black - 255=100%)
							3	3	0-255	WARM WHITE - PIXEL #2 Cool White (0=Black - 255=100%)
							4	4	0-255	AMBER - PIXEL #2 Warm White (0=Black - 255=100%)
							5	5	0-255	WARM WHITE - PIXEL #3 Cool White (0=Black - 255=100%)
							6	6	0-255	AMBER - PIXEL #3 Warm White (0=Black - 255=100%)
							7	7	0-255	WARM WHITE - PIXEL #4 Cool White (0=Black - 255=100%)
							8	8	0-255	AMBER - PIXEL #4 Warm White (0=Black - 255=100%)
1						3	9	9	0-255	DIM-TO-WARM - All PIXELS 1,800K - 3,200K (0=Black - 255=100%)
		1							0-255	DIM-TO-WARM - PIXEL #1 1,800K - 3,200K (0=Black - 255=100%)
		2							0-255	DIM-TO-WARM - PIXEL #2 1,800K - 3,200K (0=Black - 255=100%)
		3							0-255	DIM-TO-WARM - PIXEL #3 1,800K - 3,200K (0=Black - 255=100%)
		4							0-255	DIM-TO-WARM - PIXEL #4 1,800K - 3,200K (0=Black - 255=100%)
										SHUTTER / STROBE
									0-31	NO Function
									32-95	Variable Strobe Effect SLOW to FAST
					3	4		10	96-127	LEDs ON
									128-159	Pulse Effect In Sequence SLOW to FAST
									160-191	LEDs ON
									192-223	Random Strobe Effect SLOW to FAST
									224-255	LEDs ON
			3	3	4	5		11	0-255	MASTER DIMMER 0 to 100%
			4	4	5	6		12	0-255	MASTER DIMMER FINE (16 bit) 0 to 100%

ELATION® DTW BLINDER 700 IP™

DMX Channel Values / Functions (13 Total Channels)

Features are subject to change without any prior written notice.

**Control of PIXELS depends on the fixture installation orientation.*

DMX CHANNEL MODE									VALUE	FUNCTION
01CH	02CH	04CH1	04CH	05CH	06CH1	07CH	09CH	13CH		
				5	6	7		13		DIMMING CURVE MODES
									0-20	STANDARD
									21-40	STAGE
									41-60	TV
									61-80	ARCHITECTURAL
									81-100	THEATRE
									101-255	Default to Unit Setting

CLEANING AND MAINTENANCE



C A U T I O N

Disconnect power before cleaning or maintenance.

CLEANING

Frequent cleaning is recommended to insure proper function, optimized light output, and an extended life. The frequency of cleaning depends on the environment in which the fixture operates: damp, smoky or particularly dirty environments can cause greater accumulation of dirt on the fixture's optics.

- Clean the external lens surface at least every 20 days with a soft cloth to avoid dirt/debris accumulation.
- Never use alcohol, solvents, or ammonia based cleaners.

MAINTENANCE

Regular inspections are recommended to insure proper function and extended life. There are no user serviceable parts inside this fixture, please refer all other service issues to an authorized Elation service technician. Should you need any spare parts, please order genuine parts from your local Elation dealer.

Please refer to the following points during routine inspections:

- A detailed electric check by an approved electrical engineer every three months, to make sure the circuit contacts are in good condition and prevent overheating.
- Be sure all screws and fasteners are securely tightened at all times. Loose screws may fall out during normal operation resulting in damage or injury as larger parts could fall.
- Check for any deformations on the housing, color lenses, rigging hardware and rigging points (ceiling, suspension, trussing). Deformations in the housing could allow for dust to enter into the fixture. Damaged rigging points or unsecured rigging could cause the fixture to fall and seriously injure a person(s).
- Electric power supply cables must not show any damage, material fatigue or sediments. Never remove the ground prong from the power cable.

TECHNICAL SPECIFICATIONS

SOURCE

(4) 175W 2-in-1 Warm White / Amber COB LEDs

50,000 Hour Average Lamp Life*

*May vary depending on several factors including but not limited to:
Environmental Conditions, Power/Voltage, Usage Patterns (On-Off Cycling), Control, and Dimming.

COLOR

Warm White / Amber

EFFECTS

Pixel Control

Independent Dim-To-Warm Channel Control (1,800K - 3,200K)

Electric Strobe and Variable Dimming Curves Modes

CONTROL / CONNECTIONS

9 DMX Channel Modes (13 Total Channels)

4 Touch Button Control Panel and LCD Menu Display

RDM (Remote Device Management)

IP rated 5pin DMX and powerCON TRUE1 In/Out

SIZE / WEIGHT

Length: 15.7" (400mm)

Width: 9.5" (241mm)

Horizontal Height: 16.14" (410mm)

Weight: 28.0 lbs. (12.7 kg)

ELECTRICAL / THERMAL

AC 100-240V - 50/60Hz

680W Max Power Consumption

5F to 113°F (-15°C to 45°C)

APPROVALS / RATINGS

CE | RoHs | IP65

Please Note: Specifications and improvements in the design of this unit and this manual are subject to change without any prior written notice.

PHOTOMETRIC DATA

25° Beam Diameter with Fresnel Lens

25° Beam Diameter	3 m	9.8 ft	4 m	13.1 ft	5 m	16.4 ft
	lux	fc	lux	fc	lux	fc
	1.33	4.4	1.77	5.8	2.21	7.3
WW LEDs 3,100K	9,209	856	5,347	497	3,466	322
AMBER LEDs 1,400K	870	81	510	47	335	31
FULL ON 2,940K	9,390	872	5,486	510	3,549	330

78° Beam Diameter No Fresnel Lens

78° Beam Diameter	3 m	9.8 ft	4 m	13.1 ft	5 m	16.4 ft
	lux	fc	lux	fc	lux	fc
	4.99	16.4	6.67	21.9	8.21	26.9
WW LEDs 3,100K	1,432	133	883	82	602	56
AMBER LEDs 1,400K	110	10	80	7	49	5
FULL ON 2,940K	1,440	134	897	83	609	57

DIMENSIONAL DRAWINGS

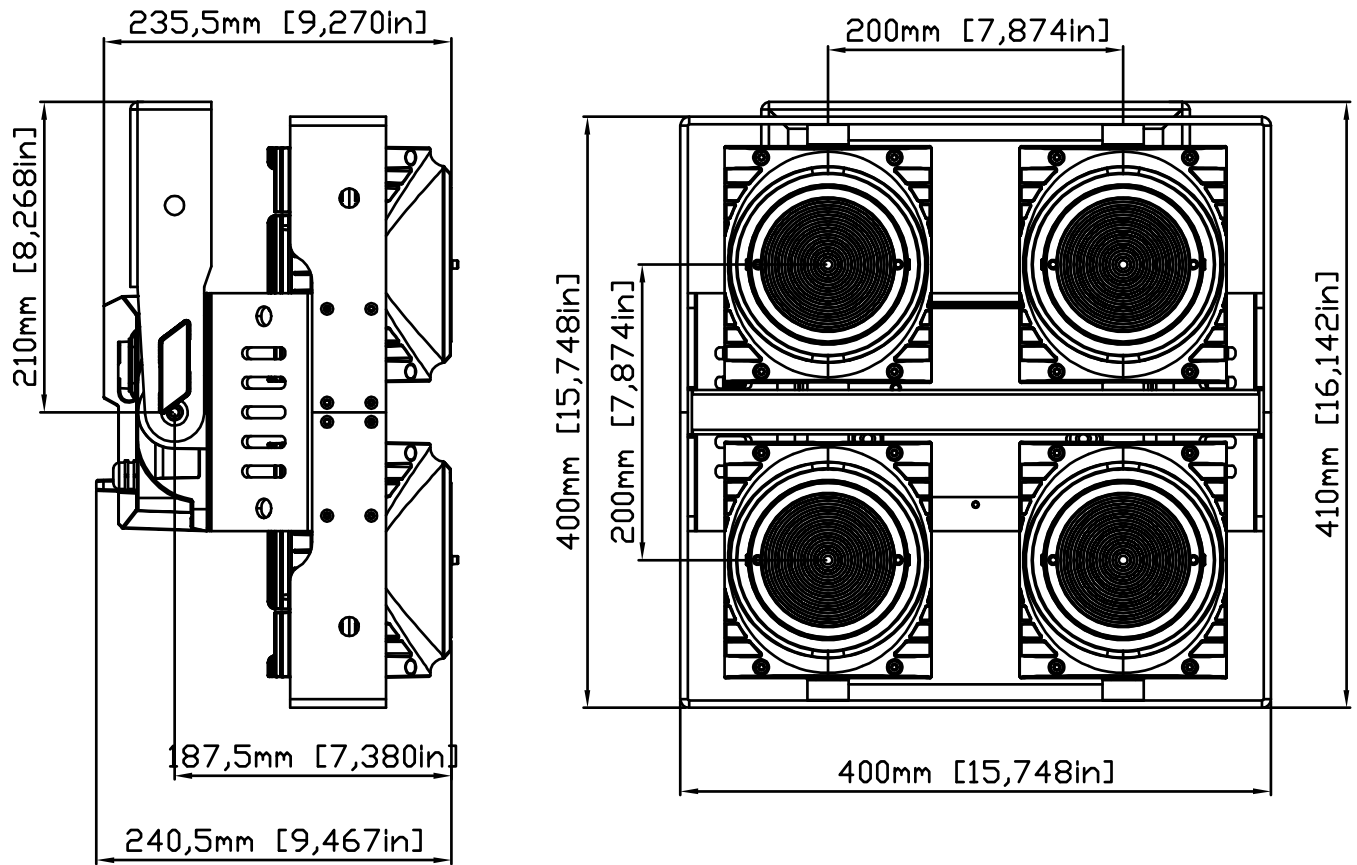

Please Note: Specifications and improvements in the design of this unit and this manual are subject to change without any prior written notice.

OPTIONAL ACCESSORIES

ORDER CODE	ITEM
TRIGGER CLAMP	Heavy Duty Wrap Around Clamp
8050000053	Omega Bracket (107mm)
NEU088	3 ft. (1m) PowerCON TRUE1 Power Link Cable
	Additional Cable Lengths Available

