

K&F SONA 6



User's Manual

Translation of the original instructions

Version 5.8

Released: 31.05.2017



**Important Information,
Please Read Before Use!**

KLING & FREITAG GmbH
Junkersstraße 14
D-30179 Hannover
TEL +49 (0) 511 96 99 70
FAX +49 (0) 511 67 37 94
www.kling-freitag.de

KLING &
FREITAG

SOUND SYSTEMS

Table of contents

1	Introduction	4
1.1	Icons Used	4
1.2	About this Manual	4
2	Product Description	5
2.1	Items Included	5
2.2	Components	5
3	Safety Instructions	6
3.1	Mounting the Speakers / Wall and Ceiling Installation	6
3.2	Notes for Mounting the Speakers	6
3.3	Preventing Hearing Damage	6
3.4	Protecting the Speakers / Operating Safety	7
4	Wall and Ceiling Installation	9
4.1	Required Tools	9
4.2	Temporary alignment of the speakers	9
4.3	Outlet for Cable and Safety elements	10
4.4	Wall Mounting of the Speaker	10
5	Stand Installation	12
6	Proper Alignment of the Loudspeakers	13
7	Wiring	14
7.1	Terminal assignment	14
7.2	Wiring Diagrams	14
7.3	Wiring Instructions	14
8	First-time Use	14
9	Directions for the 100 volt connection.	16
10	Dimensions (with Mounting Arm)	16
11	Measuring Diagrams	17
11.1	Coverage SONA 6	17
11.2	Frequency range SONA 6	17
12	Technical Specifications	19
13	EC Declaration of Conformity	20
14	Accessories	20
15	Disposal	21
15.1	Germany	21
15.2	EU, Norway, Iceland, and Liechtenstein	21
15.3	All Other Countries	21

1. Introduction

Thank you for purchasing a KLING & FREITAG product. To guarantee a trouble-free operating of the equipment and to allow your KLING & FREITAG SONA 6 system to achieve its full potential read the user's manual carefully before use. This item is a quality accessory for the SONA 6 speaker system. As the owner of a SONA 6 loudspeaker, you now have a versatile and highly professional tool which, when operated properly, is a true pleasure to use.

1.1 Icons Used



Warning

This icon indicates a risk of injury or death. Not following these instructions may result in serious health problems including potentially fatal injuries.



Caution

This icon indicates a possibly dangerous situation. Not following these instructions may cause minor injuries or damage.



Notice

This icon marks instructions for proper use of the described products. Not following these instructions may cause malfunctions or damage.



Tip

This icon marks information provided for simplified use of the described products.

1.2 About this Manual

© KLING & FREITAG GmbH. All rights reserved.

All specifications regarding the features of the described products and applicable safety guidelines provided in this manual are based on information available at the time of publishing.

We assume no responsibility for technical specifications, dimensions, weights, and properties.

All information in this manual is subject to change without notice.

All persons who use the speaker system must have this guide and all further information for safe operations available to them during assembly, disassembly, and use. The speaker system may neither be set up nor used until these user's manual has been read, understood and kept readily available in site.

All KLING & FREITAG manuals are originally authored in German.

KLING & FREITAG spare manuals are separately available for order or can be downloaded from our website: www.kling-freitag.de.

Contact Us: info@kling-freitag.de
KLING & FREITAG GMBH, Junkersstr. 14, D-30179 Hannover
Phone +49 511 96 99 70, fax +49 511 67 37 94 (other countries)

2. Product Description

2.1 Items Included

- Loudspeaker with integrated ball joint swivel arm for wall, ceiling or stand mountings
- User's Manual
- 4-pin Phoenix connector for the Phoenix socket on the speaker
- Grill dismantling tool

2.2 Components

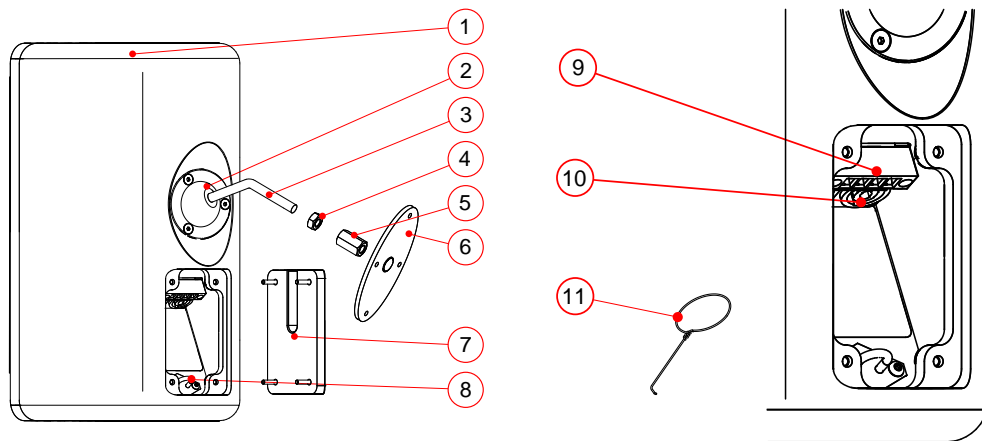

1. **Speaker enclosure**, frame-reinforced birch plywood with structured finish
2. **Clamp collar**
3. **Swivel arm with ball joint**
4. **Hexagon nut M10**, 17 mm spanner
5. **Long nut**, hexagon, M10, black version: 16 mm spanner, white version: 17 mm spanner
6. **Mounting plate with M10 bolt**
7. **Connection terminal cover** with outlet for cable and safety wire
8. **Safety eyelet** for 5 mm quick link (quick link not included but available as accessory)
9. **Phoenix connector**
10. **SpeakOn connectors**
11. **Grill dismantling tool**

3. Safety Instructions

3.1 Mounting the Speakers / Wall and Ceiling Installation



Warning

Have all installation works including suspension as well as wall or ceiling mount performed by qualified event technicians or appropriately trained persons.

Only qualified technicians are permitted to perform the installation steps. Be sure to use personal protective equipment at all times.

The technicians installing the speaker on site are responsible for and guarantee safe setup and use.

Never use signal cables or power cords for suspending, aligning, or securing the systems.

Before installing, check the stability, strength, and materials of walls, ceilings, and boarding. For example, use suitable rawlplugs for wall panels and make sure the strength is sufficient.

Be sure to tighten all bolts and screws to the specified torque.

Unless otherwise stated, use only KLING & FREITAG original parts for mounting the speakers. Never use other parts (in particular, parts not made by KLING & FREITAG).

Make sure all fittings used are suitable for the task at hand and meet all relevant safety requirements.

Ensure that all connections are secured against coming loose and that only authorized, statically tested and correctly sized supports, mounting equipment, wire ropes and chains are used.

Be sure to always visually inspect all safety-related speaker and accessory components before use. If there are signs of wear, cracks, or deformation, etc., replace the affected parts immediately. Visual inspection also includes checking all screwed connections of supporting components.

The information described here does not relieve the user of the duty to follow the given safety requirements and legal regulations.

Fixed installations (stationary):

- For fixed installations without a safety element, secure the long nut and the M10 nut from loosening. You can do this by using threadlocking adhesives or sealants.

Mobile installations (non-stationary):

- Always secure the speaker with a second independent safety device to prevent falling.
- To do so, use an approved safety rope with a 5 mm quick link on the safety eyebolt of the speaker enclosure. You can get an appropriate quick link available as an accessory from KLING & FREITAG.

3.2 Notes for Mounting the Speakers



Caution

Mount the speakers securely. To avoid injury or damage, always be sure to mount the speakers securely so that they do not fall. Please note that speakers can move as a result of vibrations. To prevent them from falling from their mounted position, they must be secured properly. Run the cables in a way that nobody can trip over them.

The stability of stacked systems (also valid for the use of stands and distance rods!) is contingent upon the following stability requirement:

Stacked systems may not fall over even if they are inclined by 10° in each direction. If this requirement is not fulfilled, then it is necessary to take steps to achieve compliance. Possible measures include strapping it to an appropriate base structure or fastening it using safety straps.

3.3 Preventing Hearing Damage



Caution

Keep your distance from operating speakers. This equipment is capable of delivering sound pressure levels in excess of 90 dB SPL, which may cause permanent hearing damage.

3.4 Protecting the Speakers / Operating Safety

Notice

In general, audio signals must not be overdriven. This may be caused by mixing consoles, equalizers, effect equipment, etc. and should be indicated on this equipment. When a power amplifier is overloaded at the output (clipping), then the amplifier should activate a clipping warning signal. Power amplifiers can also be overloaded at the input circuit without the amplifier signalling the clipping, i.e. when there is not sufficient headroom in the input circuit. We, therefore, recommend turning up the power amplifiers all the way and adjusting the level before the power amplifier in order to avoid overloading the input circuit. In any case, the signal must be reduced as soon as it sounds unnaturally distorted.

Operations without CD 44 Controller:

- To protect the speakers from being destroyed and to avoid fire hazard, they should only be operated with professional power amplifiers with a maximum rated output power of 200 W @ 8 Ohm.
- If power amplifiers have power ratings lower than 100 W @ 8 Ohm, then it is imperative that the amplifiers have clipping limiters. Alternately, you can also insert a clipping limiter before the amplifier.
- To protect the loudspeaker from mechanical damage when high SPL is required a highpassfilter of 24 dB/oct. at 60 Hz has to be inserted into the signal chain.

Operations with CD 44 Controller:

- For optimal performance and operating safety of the SONA 6 speakers we recommend using the system controller K&F CD 44.
- When operating the loudspeaker with amplifiers without clipping limiter and nominal amplifier power less than 100 W requires to set a Limit Reduction of 3 dB for the K&F CD 44 controller. You can find more detailed information about this option in the K&F CD 44 hardware user's manual.
- The destruction of speakers and the risk of fire as a result of a very rare power amplifier or speaker defect may not be avoided by the controller in any case.

For damage caused by

- overloading the speakers or
- using power amplifiers with other than the recommended maximum output power

we do not assume warranty and excludes liability for possible consequential damage.

The following signals may damage the speakers:

- clipping power amplifiers
- permanent high-level signals with high frequency and continuous noise from feedback,
- permanently distorted high-level signals,
- noises, which occur when the amplifier is on while equipment is being connected, disconnected or switched on.

Do not install devices in any of the following places:

- where the devices are permanently exposed to direct sunlight.
- where the devices are exposed to high moisture or rain.
- where the devices are exposed to strong vibrations and dust.

Avoid damage caused by the speakers' magnetic fields

Speakers are permanently surrounded by a magnetic field, even when they are not connected. Therefore, during transport and placement of the speakers, it is important to ensure that there is a sufficient distance between the speakers and magnetic data media and computer/video monitors (except flat panels).

4. Wall and Ceiling Installation

4.1 Required Tools

- T25 Torx key
- 16 mm spanner (only black version)
- 17 mm spanner (2 x for white version)
- Mounting accessories for installation on walls or ceilings

4.2 Temporary alignment of the speakers



Tip

Loosen one or two of the three Torx screws **only**. This way you can avoid having to tighten a screw that got covered by the Mounting Arm while you aligned the speaker.

Loosen this screw(s) just enough so that you can move the Mounting Arm with some resistance. This will simplify the final alignment of the speaker. This will simplify the final alignment of the speaker.

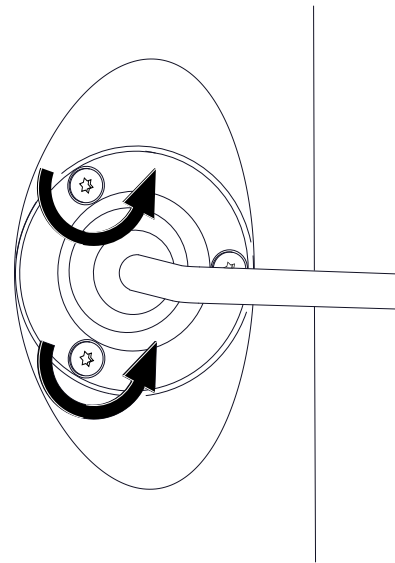

Align the loudspeaker arm as desired, and then retighten the Torx screws that you previously loosened.

Tighten the screws enough so that the speaker reliably keeps its position. Using excessive force to tighten the screws can result in irreparable destruction of the threads!

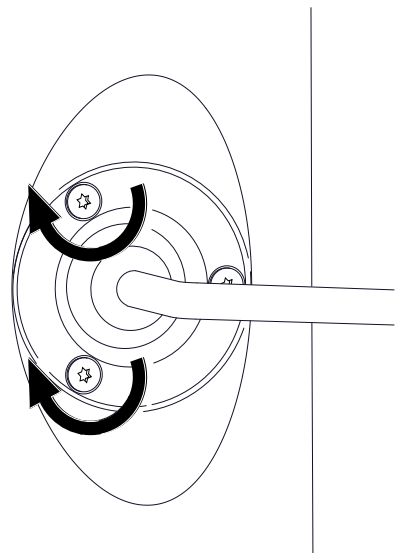

Notice

4.3 Outlet for Cable and Safety elements

To connect the speaker and attach a safety element, you must open the cover on the rear side of the speaker.

1. Loosen the screws on the cover on the rear side of the speaker with a T25 Torx key.
Remove the cover.

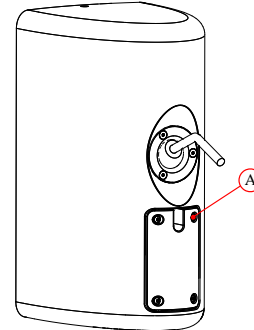

2. Connect the safety element to the safety eye in the speaker using the chain quick link.
Connect the speaker via the Speakon plug or the Phoenix connector.
First lay the safety element and then the speaker cable in the feedthrough slot on the cover.

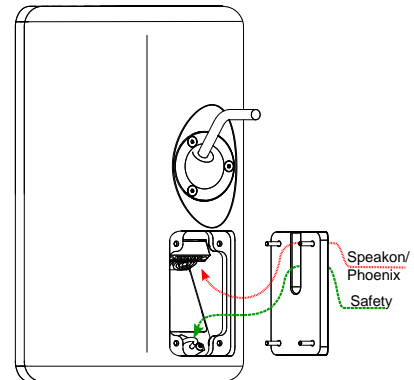

3. Place the cover back onto the rear of the speaker.
Mount the cover onto the rear side of the speaker.
The speaker is now prepared for wall, ceiling or stand mounting.

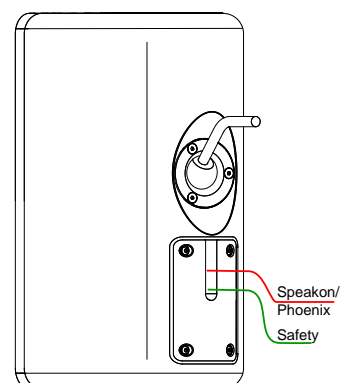

4.4 Wall Mounting of the Speaker



If people can move freely under the hung speaker, you must secure the speaker with a safety element. The BGV (government safety organisation) C1 can only be fulfilled when using such a safety device. Only when this regulation has been adhered to may the speaker be hung over people and operated.

Without this securing, the safety level corresponds to DIN 18800.

1. As an alternative to the mounting plate, you can also mount the Mounting Arm with other suitable 10 mm bolts. Make sure that you do not extend the lever arm of the wall mount.

Screw the mounting plate onto the wall or ceiling using all four mounting holes. Choose fasteners that are suitable for the wall or ceiling material. After installation, the mounting plate incl. speaker must be capable of carrying the 6-fold of its own weight. Take suitable measures to prevent the screw connection from loosening itself.

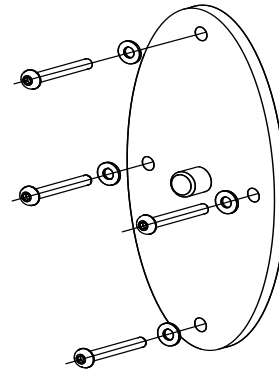

2. Attach the speaker so that the ends of the threaded rods come in contact.

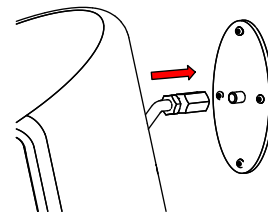

3. Turn the long nut onto the bolt of the mounting plate by hand until it touches the wall plate. Tighten it slightly using a 16 mm spanner.

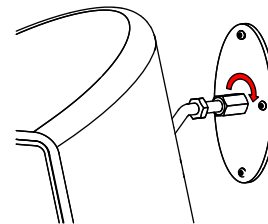

4. Screw in the counter nut M10 with a 17 mm spanner against the long nut while holding the long nut tight with a 16 mm spanner.

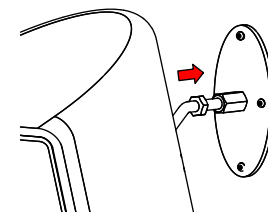

5. The speaker is now completely mounted and connected tightly to the wall.
Now adjust the speaker.
To do so, loosen the screws at the ball joint arm, as described on page 9.

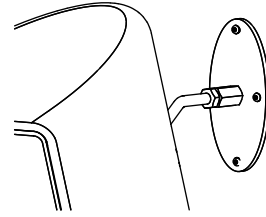

5. Stand Installation

To mount a SONA 6 speaker on a stand, you need the accessory Stand socket M10.

1. For stand mounting, you do not need the provided long nuts. Unscrew them from the mounting arm and keep them for possible later use.
2. Turn the counter nut entirely onto the thread of the mounting arm.
Place the stand adapter M10 on the mounting arm and turn it just before the counter nut.

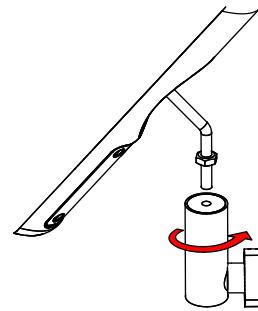

3. Screw in the counter nut M10 against the [...] using a 17 mm spanner.

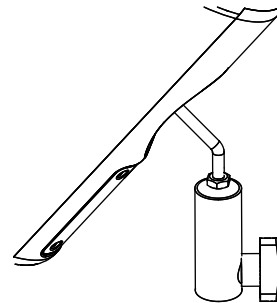

4. Loosen the clamp screw on the stand adapter and place the speaker with the stand adapter onto the top end of the stand.

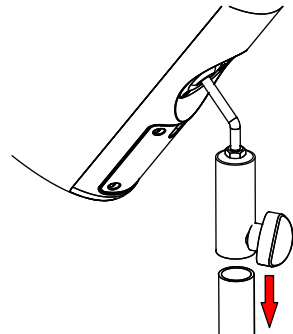

5. Make sure that the stand pole in the stand adapter reaches up to behind the clamp screw.
- Tighten the clamping screw.
- The speaker is now securely connected to the stand. Now adjust the speaker.

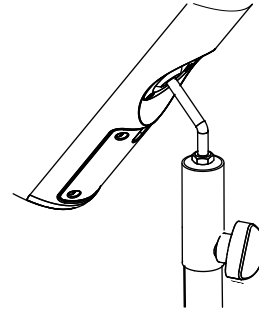

6. Proper Alignment of the Loudspeakers

Please note that precisely targeted speaker systems can significantly improve the acoustic result. It is not possible to make generalities about the alignment of specific systems because the room has a substantial influence on the signal and the audible result.

As a rule, the mid- and high-transducers of loudspeakers should be mounted above the audience's face value, so that the sound distribution cannot be shadowed.

In many cases it is advisable to mount a loudspeaker higher, so that the sound will be distributed throughout the room more evenly. Low standing systems result in a greater difference in volume between front and back seats than higher standing systems.

To simulate the correct alignment of the speakers beforehand, there are various programs such as 'EASE' or 'Ulysses'. On the homepage www.kling-freitag.de, KLING & FREITAG provides the simulation data for the speakers to be downloaded.

7. Wiring



Warning

Speaker-signal currents are potentially hazardous to the human body.

When the system is in use, make sure that the connectors are secured against inadvertent touch.

Always fully insert bared wire ends into the push connector or the Phoenix plug such that bared parts of wire can not be touched.

For speakers with Phoenix connector the bared wire ends have to be accurately screwed into the plugs.

7.1 Terminal assignment

SpeakOn connector

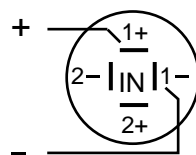

Phoenix connector

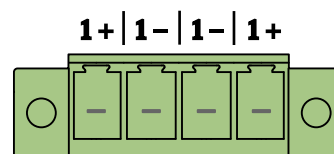

Pin 1 is parallel at all connections.

7.2 Wiring Diagrams

You will find all necessary pin diagrams for operations with the CD 44 Controller in the user's manual of the CD 44! This applies for use with and without the K&F Subwoofer.

7.3 Wiring Instructions

Notice

- Before connecting your SONA 6 loudspeaker switch off all equipment and turn down all level controls.
- Only use high-quality speaker cables with a sufficient wire gauge. The wire gauge depends on the length of the speaker cable.
- For connections to the power amplifier inputs, please use 2-pin shielded microphone cable (balanced) with high-quality connectors.
- Avoid creating ground loops.
- Be sure to note the pinouts shown in these user's manual.
- Make sure that the +/- polarity of the speakers at the amplifier is correct. When simultaneously using power amplifiers from different manufacturers, be sure to use the correct specific pin configuration. It may be necessary to modify the pin configuration on the power amplifiers or on the connectors leading to them.
- Upon completing wiring, ensure that the connected speaker channels are working in phase, for example, using a voltage tester. When the connected channels are used simultaneously, you can identify out-of-phase statuses by bass cancellation or mid-frequency signals (e.g. voices) that cannot be located properly.
- If several loudspeakers are connected, the signal can be linked through parallel from one loudspeaker to the next. Please make sure that the total impedance of the loudspeakers $R(\text{Ohm})$ is not lower than the minimal impedance indicated on the power amplifier. $1/R1 + 1/R2 + 1/R3 + \dots = 1/R_{\text{total}}$

8. First-time Use

Notice

- Switch off all equipment and turn down all level controls of the mixing console and the power amplifiers.
- Wire the SONA 6 systems.
- Switch on the mixing console **first**, then the controller and the power amplifier. Always use the before mentioned switching order. Otherwise switching noises may damage the sound system.
- If there is interference, turn off all appliances in the reverse order and check all cable connections.
- Successively turn up the individual power amplifier channels and send a signal with low volume to the system. Check whether the audio is properly routed to the appropriate speakers. Make sure no noise is heard through those speakers.
With controller: The SIGNAL LEDs of the CD 44 Controller will light up if the output level is higher than -45 dB. Your system should now be ready for operation.
- Turning down the input level controls may not always prevent distortions in the input section of the power amplifier, especially if this section has a relatively low headroom. A clipping signal may not be displayed by the clipping indicator then! To prevent signal interruptions or damages to the speakers, turn the level controls of the power amplifier to the maximum position, if possible. Set the output level of the mixing console or the controller to a level that doesn't overload the power amplifiers or decrease the limiter threshold of the controller.
- When turning off the system, the input controls for the power amplifiers should be turned down first followed by the power switches of the amplifiers. After that, the other appliances can be turned off.

9. Directions for the 100 volt connection.

KLING & FREITAG speakers with '100 V' option are fitted with high-quality transformers. This serves to minimize loss of sound. Highly professional sound reinforcement results can be achieved using '100 Volt' KLING & FREITAG speakers.

Reasons for choosing Speakers with 100 Volt Transformers:

- Reduction in conduction loss.
- Easy installation of a loudspeaker network due to simple parallel wiring. The sum of the output power of the individual speakers (stated as VA = W) must not exceed the output power of the 100 Volt amplifier.
- Speakers are galvanically isolated.
- Speakers can be integrated into existing 100 Volt systems.

10. Dimensions (with Mounting Arm)

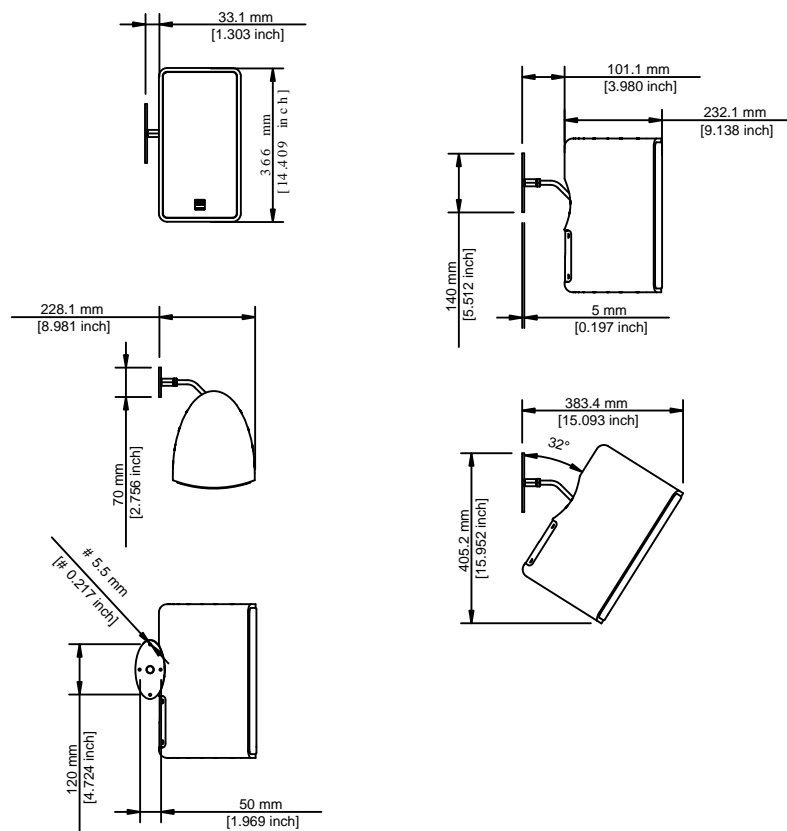

11. Measuring Diagrams

11.1 Coverage SONA 6

Horizontal coverage patter

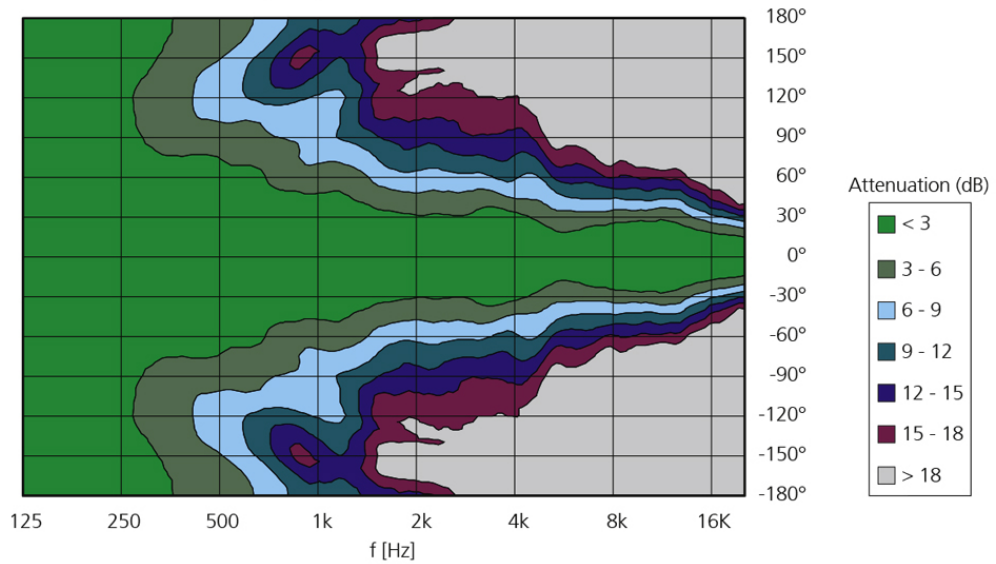

Vertical coverage patter

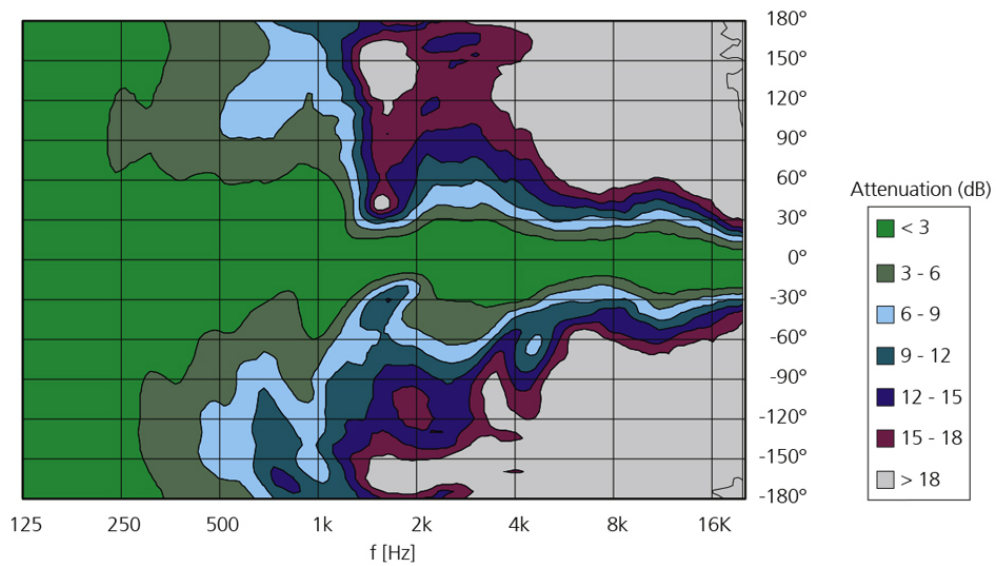

11.2 Frequency range SONA 6

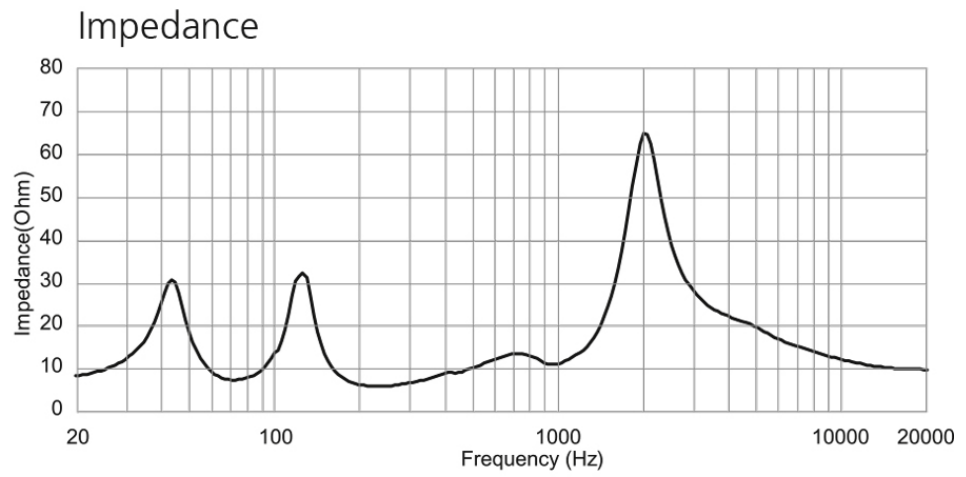
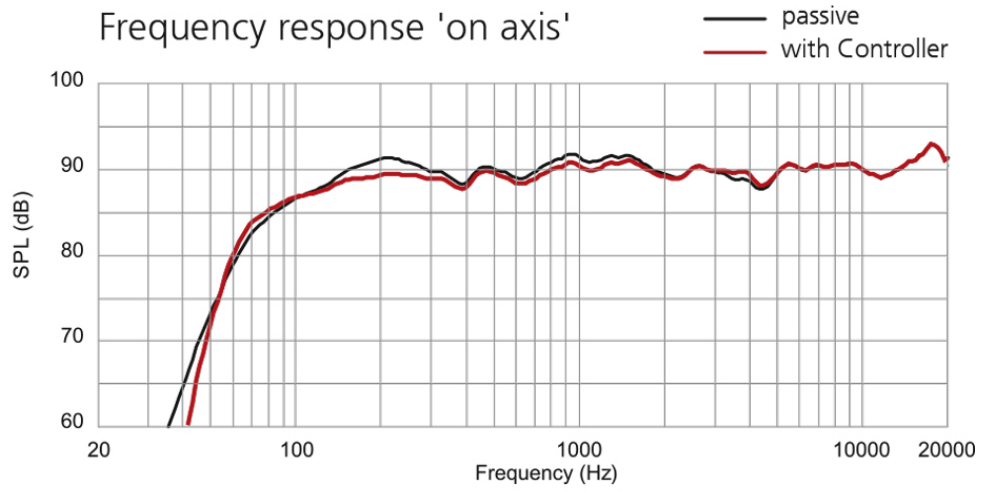

12. Technical Specifications

SONA 6	
Concept	Passive 2-Way-bass reflex system
Operated with	K&F PLM+ Serie, K&F D-Serie, Lab.Gruppen IPD 2400, K&F SystemRack, K&F TOPAS, passiv at linear Amps
Frequency range @-10 dB	65 Hz – 26 kHz (passiv) 86 Hz – 26 kHz (LCut mode) 60 Hz – 25 kHz (FR mode)
Frequency range -3 dB	80 Hz – 20 kHz (passiv) 106 Hz – 20 kHz (LCut mode) 65 Hz – 20 kHz (FR mode)
Coverage angle (nominal)	90° x 60° (hor. x vert.), rotatable CD-Horn
Nominal power handling	100 watts
program	200 watts
peak	400 watts
Max. SPL (1 m)	118 dB (SPL Peak/1 m)
Impedance nominal	8 Ohm
loudspeaker/channel	see matrix
Components	8" low-mid chassis, 1" compression driver with 45 mm Titanium diaphragm
Connection	2 x speakON® 4-pol. NL4MP (1+/-), 1 x Phoenixbuchse (parallel)
Enclosure Design	
	Design enclosure out of Multiplex, highly resistant structure paint (PU) in black or white, safety eyelet for quick chain link, ball joint mounting arm (104 mm) with mounting plate, sunk-in, to the bottom faced and concealed connectors, exchangeable front grille, rotatable logo
Dimensions (H x W x D)	195 x 366 x 232 mm
Weight	6.8 kg
Color	RAL 9005 (black) oder RAL 9010 (white)
Optional	'100 Volt' mit 50/100/150 VA Ringkernübertrager (13.9 kg), 'special finish in RAL colours'

13. EC Declaration of Conformity

applicable to all products designated hereafter and distributed by KLING & FREITAG GmbH including model variants unless these products have been altered afterwards.

Loudspeaker systems:

ACCESS B5	E 90 MK II	SEQUENZA 10 N/W
ACCESS B10	LINE 212 -6/-9	SEQUENZA 10 B
ACCESS T5/T9	NOMOS LS CIN	SEQUENZA 5 W
CA 106	NOMOS LS II	SEQUENZA 5 B
CA 205 *) **)	NOMOS LT	SONA 5 **)
CA 1001	NOMOS XLC	SONA 6
CA 1201 *)	NOMOS XLS	SONA 8
CA 1215 -6/-9	NOMOS XLT	SONA SUB **)
CA 1515 -6/-9	PASSIO **)	SONS SUB II
GRAVIS 8 W	PASSIO SUB 12	SW 112
GRAVIS 12 N/W*	PASSIO SUB 15	SW 115D *)
GRAVIS 12+ N/W/XW	SCENA 15	SW 115E
GRAVIS 12+ N/W/XW AS		SW 118E
GRAVIS 15 N/W/XW		SW 212E

*) These products are discontinued.

***) These systems are not covered by the Low Voltage Directive because of the rated voltage used.

We declare that the designated product(s) are in conformity with the protection requirements imposed by the following EU directives:

Electromagnetic Compatibility (EMC) Directive	(2004/108/EC)
Low Voltage Directive	(2006/95/EC)
Technical documentation for the assessment of electrical and electronic products with respect to the restriction of hazardous substances	(VDE 0042-12:2013-02)

The operating conditions specified in these user's manual must be met accordingly.

This declaration is issued under sole responsibility of the manufacturer:

KLING & FREITAG GmbH
Junkersstraße 14, D-30179 Hannover, Germany



Hannover, 30th March 2015

Jürgen Freitag
 (Managing Director / CEO)

14. Accessories

- 5 mm chain quick link, stamped. For use with the safety eye on the speaker.
- K&F Stand Adapter, M10

15. Disposal

Please recycle the packaging material of the device.

15.1 Germany

Don't dispose of waste electrical equipment through household waste.

Don't deliver it to official recycling points either.

All KLING & FREITAG products are plain business-to-business (B2B) products. Therefore, KLING & FREITAG GmbH is exclusively responsible for disposing of all KLING & FREITAG waste equipment marked with a garbage-can icon. Please call the below phone number when you have a KLING & FREITAG product (marked with the garbage-can icon) for disposal. We will offer you a straightforward and professional disposal at no cost.

KLING & FREITAG equipment with no such icon was sold before 24 March 2006; in that case, the owner is legally responsible for disposal. We will, however, gladly assist you by naming appropriate ways of disposal.

For further disposal information of KLING & FREITAG waste products, call +49 (0)511-96 99 7-0

Background information: The Electrical and Electronic Equipment and Appliances Act (ElektroG) is the German implementation of the European (EU) Waste Electrical and Electronic Equipment Directive (WEEE, 2002/96/EC).

Therefore, starting on 24 March 2006, KLING & FREITAG GmbH has marked all products subject to the WEEE that are distributed in Germany with an icon showing a crossed-out garbage can with a white bar below it. The icon indicates that the equipment was distributed on or after 24 March 2006 and must not be disposed of through household waste.

KLING & FREITAG GmbH is legally registered as a manufacturer with the German waste-equipment registration authority (EAR). The WEEE registration number is: DE64110372.

We substantiated towards the EAR that our products are for B2B trade only.

15.2 EU, Norway, Iceland, and Liechtenstein

Don't dispose of waste electrical equipment through household waste.

Starting on 13 August 2005, KLING & FREITAG GMBH has marked all products subject to the WEEE directive that are distributed in any member state of the European Union (except Germany), Norway, Iceland, or Liechtenstein with an icon showing a crossed-out garbage can with a white bar below it.

The icon indicates that the equipment was distributed on or after 13 August 2005 and must not be disposed of through household waste.

Unfortunately, the European WEEE directive was implemented in different national legislation in the EU member states, making it impossible to offer a consistent disposal solution throughout Europe.

The local distributor (sales partner) in the respective country is responsible for complying with the applicable legislation.

Contact your retailer or the local authorities for information on the regulations applicable in any EU member state (except Germany).

15.3 All Other Countries

Contact your retailer or the local authorities for information on the regulations applicable in any country not listed above.

INDEX

• 100 V.....	16
• Accessories.....	21
• Alignment.....	9,13
• Components.....	5
• Dimensions.....	16
• Disposal.....	21
• EC Declaration of Conformity.....	20
• First-time Use.....	15
• I/O.....	14
• Items Included.....	5
• Measuring Diagrams.....	17
• Mounting.....	9
• Product Description.....	5
• Safety Instructions.....	6
• Speaker stand.....	12
• Technical Specifications.....	19
• Tool.....	9
• Wiring.....	14
• Wiring Diagrams.....	14