

# K&F GRAVIS 12+



 Please note the additional Information for use with K&F GRAVIS 12

## User's Manual

Translation of the original instructions

Version 4.2

Released: 15.08.2017



**Important Information,  
Please Read Before Use!**

KLING & FREITAG GmbH  
Junkersstraße 14  
D-30179 Hannover  
TEL +49 (0) 511 96 99 70  
FAX +49 (0) 511 67 37 94  
[www.kling-freitag.de](http://www.kling-freitag.de)





---

## Table of contents

|           |   |           |
|-----------|---|-----------|
| <b>1</b>  | <b>Introduction</b>                                   | <b>5</b>  |
| 1.1       | Icons Used  | 5         |
| 1.2       | About this Manual                                     | 5         |
| <b>2</b>  | <b>Product Description</b>                            | <b>6</b>  |
| 2.1       | Items Included  | 6         |
| 2.2       | System Requirements                                   | 6         |
| 2.3       | Components  | 6         |
| <b>3</b>  | <b>Safety Instructions</b>                            | <b>7</b>  |
| 3.1       | Mounting the Speakers / Wall and Ceiling Installation | 8         |
| 3.2       | Notes for Mounting the Speakers                       | 8         |
| 3.3       | Preventing Hearing Damage                             | 8         |
| 3.4       | Protecting the Speakers / Operating Safety            | 8         |
| <b>4</b>  | <b>Suspending the Speakers</b>                        | <b>10</b> |
| 4.1       | Securing the Speakers (Secondary Safety Device)       | 10        |
| <b>5</b>  | <b>Arrayed Speaker (Cluster)</b>                      | <b>10</b> |
| 5.1       | Horn not rotated                                      | 11        |
| 5.2       | With rotated Horn                                     | 11        |
| <b>6</b>  | <b>Rotating the high frequency horn</b>               | <b>12</b> |
| <b>7</b>  | <b>Wiring Instructions</b>                            | <b>13</b> |
| <b>8</b>  | <b>First-time Use</b>                                 | <b>13</b> |
| <b>9</b>  | <b>Configuration and Connecting Diagram</b>           | <b>14</b> |
| 9.1       | Compatibility with GRAVIS 12                          | 14        |
| 9.2       | Controller Mode 'Full-Range'                          | 14        |
| 9.2.1     | Controller Mode with Subwoofer in Overlap Mode        | 15        |
| 9.3       | Operations with an additional Subwoofer               | 16        |
| <b>10</b> | <b>Dimensions</b>                                     | <b>17</b> |
| <b>11</b> | <b>Measuring Diagrams</b>                             | <b>18</b> |
| 11.1      | Frequency range GRAVIS 12+ N                          | 18        |
| 11.2      | Frequency range GRAVIS 12+ W                          | 18        |
| 11.3      | Frequency range GRAVIS 12+ XW                         | 19        |
| 11.4      | Coverage GRAVIS 12+ N                                 | 20        |
| 11.5      | Coverage GRAVIS 12+ W                                 | 21        |
| 11.6      | Coverage GRAVIS 12+ XW                                | 22        |
| <b>12</b> | <b>Technical Specifications</b>                       | <b>23</b> |
| 12.1      | Technical Specifications GRAVIS 12+ W                 | 23        |
| 12.2      | Technical Specifications GRAVIS 12+N                  | 24        |
| 12.3      | Technical Specifications GRAVIS 12+ XW                | 25        |

---

|           |  |           |
|-----------|--|-----------|
| <b>13</b> | <b>EC Declaration of Conformity</b>    | <b>26</b> |
| <b>14</b> | <b>Accessories</b>                     | <b>26</b> |
| <b>15</b> | <b>Care and Maintenance</b>            | <b>29</b> |
| <b>16</b> | <b>Transportation and Storage</b>      | <b>29</b> |
| <b>17</b> | <b>Disposal</b>                        | <b>29</b> |
| 17.1      | Germany                                | 29        |
| 17.2      | EU, Norway, Iceland, and Liechtenstein | 30        |
| 17.3      | All Other Countries                    | 30        |

---

## 1. Introduction

Thank you for purchasing a KLING & FREITAG product. To guarantee a trouble-free operating of the equipment and to allow your KLING & FREITAG GRAVIS 12+ system to achieve its full potential read the user's manual carefully before use. As the owner of a GRAVIS 12+ loudspeaker, you now have a versatile and highly professional tool which, when operated properly, is a true pleasure to use.

### 1.1 Icons Used



Warning

This icon indicates a risk of injury or death. Not following these instructions may result in serious health problems including potentially fatal injuries.



Caution

This icon indicates a possibly dangerous situation. Not following these instructions may cause minor injuries or damage.



Notice

This icon marks instructions for proper use of the described products. Not following these instructions may cause malfunctions or damage.



Tip

This icon marks information provided for simplified use of the described products.

### 1.2 About this Manual

© KLING & FREITAG GmbH. All rights reserved.

All specifications regarding the features of the described products and applicable safety guidelines provided in this manual are based on information available at the time of publishing.

We assume no responsibility for technical specifications, dimensions, weights, and properties.

All information in this manual is subject to change without notice.

**All persons who use the speaker system must have this guide and all further information for safe operations available to them during assembly, disassembly, and use. The speaker system may neither be set up nor used until these user's manual has been read, understood and kept readily available in site.**

All KLING & FREITAG manuals are originally authored in German.

KLING & FREITAG spare manuals are separately available for order or can be downloaded from our website: [www.kling-freitag.de](http://www.kling-freitag.de).

Contact Us: [info@kling-freitag.de](mailto:info@kling-freitag.de)  
KLING & FREITAG GMBH, Junkersstr. 14, D-30179 Hannover  
Phone +49 511 96 99 70, fax +49 511 67 37 94 (other countries)

## 2. Product Description

The GRAVIS 12+ is a high performance all-round speaker whose two monitor angles allow for it to be used not only as a highly professional mid-high range PA speaker, but also as a versatile stage monitor. To fly the speaker, you can use the unique Kling & Freitag 'VariPoint'® Flying Points with the quick connecting 'K&F Lifting Pin', the 'K&F eyebolt' or other K&F accessories. Its elegant design suitable for galas or TV provides for an attractive appearance on all stages, clearly setting the GRAVIS 12+ apart from other PA speakers. All variants have rotatable horns. All variants can also be supplied with an axis-symmetrical design (option 'AS').

The coverage angle of the models are:

|                |            |
|----------------|------------|
| GRAVIS 12+ N:  | 65° x 50°  |
| GRAVIS 12+ W:  | 90° x 50°  |
| GRAVIS 12+ XW: | 110° x 50° |

### 2.1 Items Included

- PA-Lautsprecher with 5 x K&F 'Varipoint' and pole mount adapter for versatile, quick and save installation.
- (1x) User manual

### 2.2 System Requirements

Lab.gruppen IPD 2400

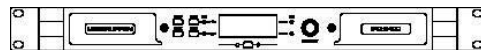

or

K&F PLM+ 20k44 (SystemAmp, ProRental)  
K&F PLM+ 12k44 (SystemAmp, ProRental)

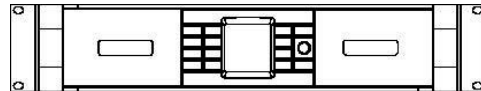

with

K&F Connector Panel CP+  
Terminalpanel (optional)

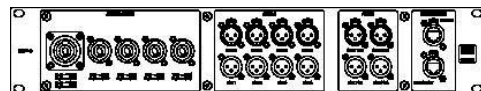

or

K&F D200:4 (SystemAmp, InstallSound)  
K&F D120:4 (SystemAmp, InstallSound)  
K&F D80:4 (SystemAmp, InstallSound)

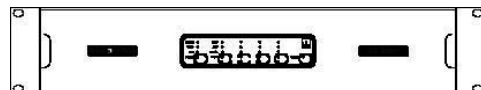

or

K&F SystemRack

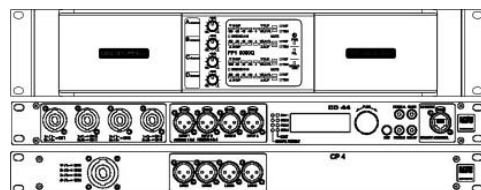

## 2.3 Components

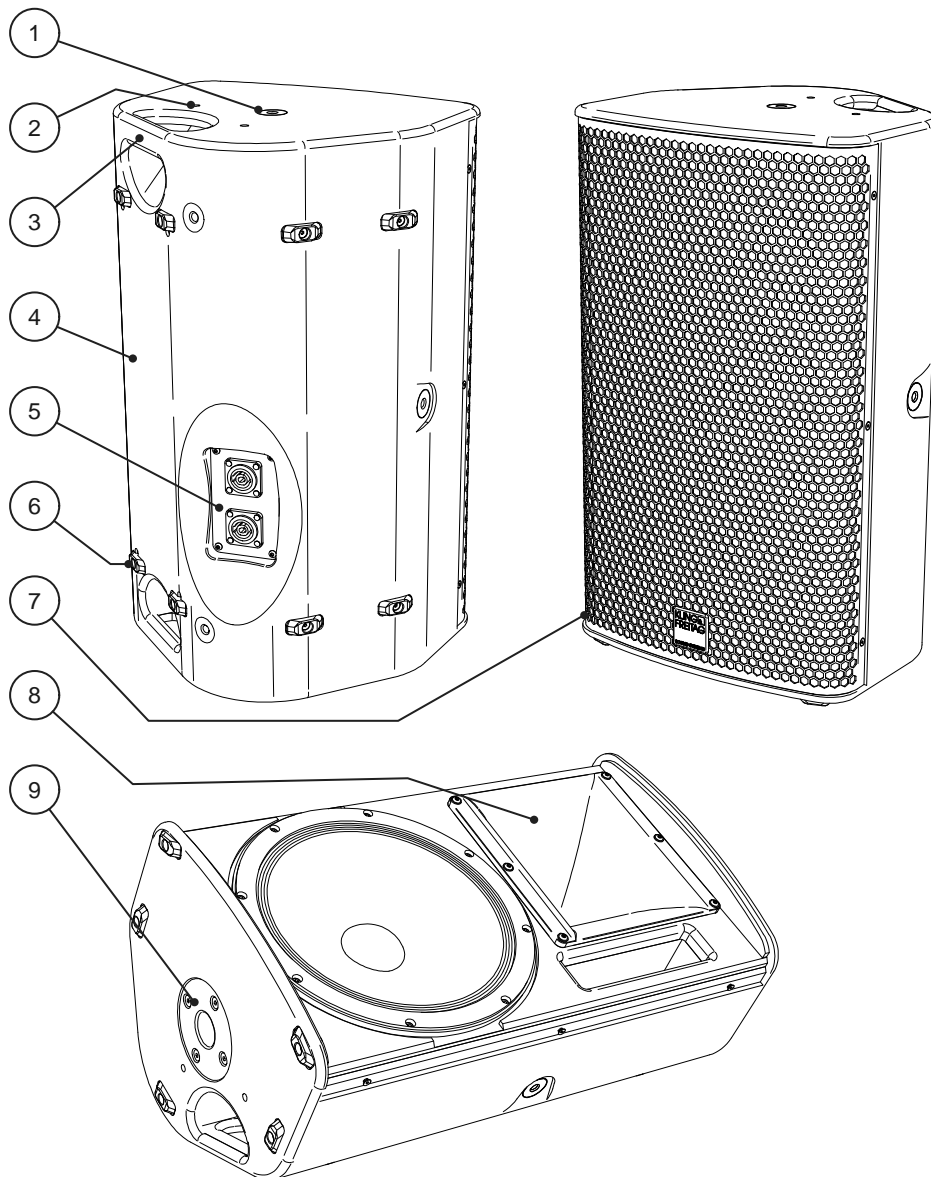

1. **(5x) flying and securing point K&F 'VariPoint'** for use with the 'K&F Lifting Pin', K&F eyebolt or other K&F accessories.
2. **Speaker handle with drill hole** prevents liquids from building up in the handle area.
3. **(2x) handle**
4. **speaker enclosure**
5. **(2x) SpeakOn connector 4-pin NLT4MP (parallel)**
6. **(13x) Plastic gliding foot** 5x on the bottom, 4 x on the 35° monitor side, 4 x on the 55° monitor side
7. **Front grille** with a hexagonal hole pattern and acoustic foam behind it
8. **High frequency horn** rotatable
9. **Cabinet Flange** for using the loudspeaker on a speaker stand

## 3. Safety Instructions

### 3.1 Mounting the Speakers / Wall and Ceiling Installation



Warning

Suspended loads pose a safety risk.

Only qualified technicians are permitted to perform the installation steps. Be sure to use personal protective equipment at all times.

The technicians installing the speaker on site are responsible for and guarantee safe setup and use.

Never use signal cables or power cords for suspending, aligning, or securing the systems.

Before installing, check the stability, strength, and materials of walls, ceilings, and boarding. For example, use suitable rawplugs for wall panels and make sure the strength is sufficient.

Note that the suspension points on the hall ceiling (i.e. shackles, attachment points, or chain hoists) must comply with the DGUV regulations 17 and 18 or similar locally applicable accident-control standards. The maximum load must have been certified by an authorized expert.

Be sure to tighten all bolts and screws to the specified torque.

Unless otherwise stated, use only KLING & FREITAG original parts for mounting the speakers. Never use other parts (in particular, parts not made by KLING & FREITAG).

Make sure all fittings used are suitable for the task at hand and meet all relevant safety requirements.

Ensure that all connections are secured against coming loose and that only authorized, statically tested and correctly sized supports, mounting equipment, wire ropes and chains are used.

Be sure to always visually inspect all safety-related speaker and accessory components before use. If there are signs of wear, cracks, or deformation, etc., replace the affected parts immediately. Visual inspection also includes checking all screwed connections of supporting components.

The information described here does not relieve the user of the duty to follow the given safety requirements and legal regulations.

### 3.2 Notes for Mounting the Speakers



Warning

Mount the speakers securely. To avoid injury or damage, always be sure to mount the speakers securely so that they do not fall.

Note that speakers can move as a result of vibrations. To prevent them from falling from their mounted position, they must be secured properly.

Run the cables in a way that nobody can trip over them.

### 3.3 Preventing Hearing Damage



Caution

Keep your distance from operating speakers. This equipment is capable of delivering sound pressure levels in excess of 90 dB SPL, which may cause permanent hearing damage.

### 3.4 Protecting the Speakers / Operating Safety

**Notice**

GRAVIS 12+ speakers may only be used in combination with a K&F SystemAmp/SystemRack.

In general, audio signals must not be overdriven. This may be caused by mixing consoles, equalizers, effect equipment, etc. and should be indicated on this equipment. When a power amplifier is overloaded at the output (clipping), then the amplifier activates a clipping warning signal. In any case, the signal must be reduced as soon as it sounds unnaturally distorted.

**For damage caused by**

- overloading the speakers or
- using the speakers without K&F SystemAmp/SystemRack

we do not assume warranty and excludes liability for possible consequential damage.

**The following signals may damage the speakers:**

- permanent high-level signals with high frequency and continuous noise from feedback,
- permanently distorted high-level signals,
- noises, which occur when the amplifier is on while equipment is being connected, disconnected or switched on.

**Do not install devices in any of the following places:**

- where the devices are permanently exposed to direct sunlight.
- where the devices are exposed to high moisture or rain.
- where the devices are exposed to strong vibrations and dust.

**Damage caused by the speakers' magnetic fields**

Speakers are permanently surrounded by a magnetic field, even when they are not connected. Therefore, during transport and placement of the speakers, it is important to ensure that there is always approx. 1 m between the speakers and magnetic data media and computer/video monitors.

## 4. Suspending the Speakers



Warning

By using the K&F 'Lifting Pin' or the M10 x 17 eyebolts available as optional accessories from Kling &Freitag, you can fly the speaker.

According to DGUV accident prevention regulations, a secondary safety component must be used when speakers are suspended with K&F LIFTING PINS.

This secondary safety component must allow no drop.



Warning

1)

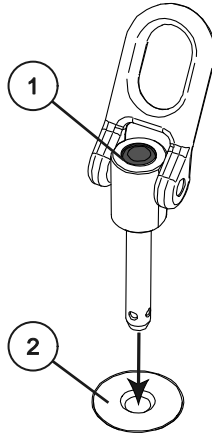

Push the release button 1 and completely insert the lifting pin into the flying point 2.

2)



Let go of the release button when you have completely inserted the bolt so that the release button pops back up. Ensure that you cannot pull out the lifting pin any more.



Tip

To fly the speakers or mount them on the wall or ceiling, we recommend using the accessory 'Adjustable Speaker Mount GRAVIS 12' or 'U-Mount Wall / Ceiling Bracket GRAVIS 12'.

By using these accessories, you can easily adjust mounted speakers to the desired position.

### 4.1 Securing the Speakers (Secondary Safety Device)

The flying and securing point K&F 'VariPoint', the K&F 'eyebolt' and the K&F Lifting Pin are suitable for securing a secondary safety device according to the German safety regulations BGV C1.

Heed the following specifications:

|                                     | wire length | wire diameter | max. falling height |
|-------------------------------------|-------------|---------------|---------------------|
| Wire rope according to DIN EN 56927 | 1m          | 5mm           | 0.2m                |
| Major Saveking® safety wire         | 0.6 m       | 3 mm          | 0.2m                |

## 5. Arrayed Speaker (Cluster)

If the loudspeakers are operated through K&F system controller, we recommend to use the 'Top Low Cut' switch for this operation. So you can optimize the frequency response for this application.

When operating the systems without any K&F system controller, you should decrease the frequencies below 300 Hz for 3-4 dB.

### 5.1 Horn not rotated

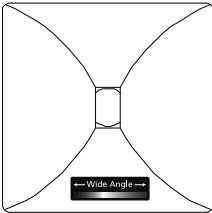

not rotated horn

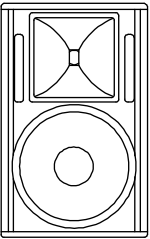

standing speakers

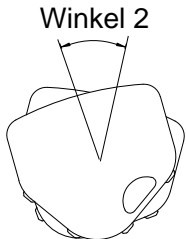

Winkel 2

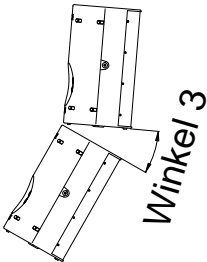

Winkel 3



Winkel 1

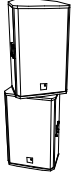

A smaller angle 3 results in a smaller vertical coverage angle but increases the sound power level.

| Combination                      | Angle 1  | Angle 2  | Angle 3   |
|----------------------------------|--|--|-----------|
| Gravis 12+ N with Gravis 12+ N   | 30°  | 40°  | 20° - 30° |
| Gravis 12+ N with Gravis 12+ W   | 35°  | 45°  |           |
| Gravis 12+ N with Gravis 12+ XW  | 40°  | 50°  |           |
| Gravis 12+ W with Gravis 12+ W   | 45°  | 55°  |           |
| Gravis 12+ W with Gravis 12+ XW  | 50°  | 60°  |           |
| Gravis 12+ XW with Gravis 12+ XW | 55°  | 65°  |           |
| Application                      | Increasing the horizontal coverage angle, e.g. for wide audience areas | Increasing the horizontal coverage angle and sound pressure level for larger distances |           |

## 5.2 With rotated Horn

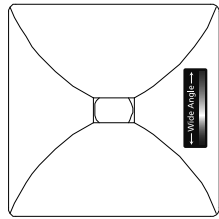

rotated horn

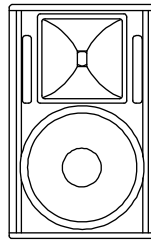

standing speakers

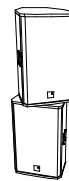
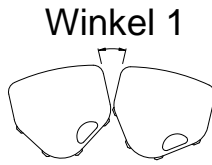
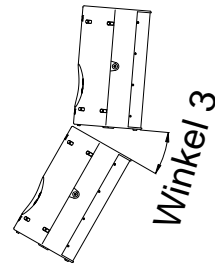
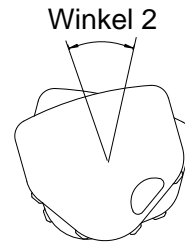

A smaller angle 3 results in a smaller vertical coverage angle but increases the sound power level.

| Combination                      | Angle 1  | Angle 2  | Angle 3  |
|----------------------------------|--|--|--|
| Gravis 12+ N with Gravis 12+ N   | 20°  | 30°  | 30°  |
| Gravis 12+ N with Gravis 12+ W   |  |  | 35°  |
| Gravis 12+ N with Gravis 12+ XW  |  |  | 40°  |
| Gravis 12+ W with Gravis 12+ W   |  |  | 45°  |
| Gravis 12+ W with Gravis 12+ XW  |  |  | 50°  |
| Gravis 12+ XW with Gravis 12+ XW |  |  | 55°  |
| Application                      | Increasing the horizontal coverage angle, e.g. for wide audience areas | Increasing the horizontal coverage angle and sound pressure level for larger distances | Increasing the vertical angle, e.g. for covering balconies |

## 6. Rotating the high frequency horn

When operating upright, the GRAVIS 12+ N has a standard practice-orientated coverage characteristic of 65° x 50° (hor. x vert.), the GRAVIS 12+ XW has 90° x 50° (hor. x vert.). When you use it as a stage monitor, you have a good coverage into the depth of the stage and an optimal lateral sound field boundary on the stage. For special uses, the horn can also be rotated.

### Required tools:

- 2.5 mm Allen key for loosening the front grille

- 3 mm Allen key for loosening the horn tweeter

**If you wish to rotate the horn, proceed as follows:**

1. Remove the screws with a 2.5 mm Allen key.
2. Remove the front grille.
3. Remove the horn screws with a 3 mm Allen key.
4. Turn the horn by 90°.
5. Screw on the horn tightly again.
6. Mount the front grille with the 6 grille screws.

## 7. Wiring Instructions

### Notice

- Before connecting your GRAVIS 12+ loudspeaker switch off all equipment and turn down all level controls.
- Only use high-quality speaker cables with a sufficient wire gauge. The wire gauge depends on the length of the speaker cable.  
**Min. Wire Gauge (mm<sup>2</sup>) = Req. Cable Length (m) / (2xSpeaker Impedance (Ohm))**
- For connections to the power amplifier inputs, use 2-pin shielded microphone cable (balanced) with high-quality connectors.
- Avoid creating ground loops.
- Be sure to note the pinouts shown in these user's manual.
- Make sure that the +/- polarity of the speakers at the amplifier is correct. When simultaneously using power amplifiers from different manufacturers, be sure to use the correct specific pin configuration. It may be necessary to modify the pin configuration on the power amplifiers or on the connectors leading to them.
- Upon completing wiring, ensure that the connected speaker channels are working in phase, for example, using a voltage tester. When the connected channels are used simultaneously, you can identify out-of-phase statuses by bass cancellation or mid-frequency signals (e.g. voices) that cannot be located properly.
- If several loudspeakers are connected, the signal can be linked through parallel from one loudspeaker to the next. Make sure that the total impedance of the loudspeakers  $R(\text{Ohm})$  is not lower than the minimal impedance indicated on the power amplifier.  **$1/R1 + 1/R2 + 1/R3 + \dots = 1/R_{\text{total}}$**

## 8. First-time Use

### Notice

- Switch off all equipment and turn down all level controls of the mixing console and the power amplifiers.
- Wire your GRAVIS 12+ systems according to the instructions in these user's manual.
- Switch on the mixing console **first**, then the controller and the power amplifier. Always use the before mentioned switching order. Otherwise switching noises may damage the sound system.
- If there is interference, turn off all appliances in the reverse order and check all cable connections.
- Successively turn up the individual power amplifier channels and send a signal with low volume to the system. Check whether the audio is properly routed to the appropriate speakers. Make sure no noise is heard through those speakers.  
**With controller:** The SIGNAL LEDs of the CD 44 Controller will light up if the output level is higher than -45 dB. Your system should now be ready for operation.

- Turning down the input level controls may not always prevent distortions in the input section of the power amplifier, especially if this section has a relatively low headroom. A clipping signal may not be displayed by the clipping indicator then! To prevent signal interruptions or damages to the speakers, turn the level controls of the power amplifier to the maximum position, if possible. Set the output level of the mixing console or the controller to a level that doesn't overload the power amplifiers or decrease the limiter threshold of the controller.
- When turning off the system, the input controls for the power amplifiers should be turned down first followed by the power switches of the amplifiers. After that, the other appliances can be turned off.

## 9. Configuration and Connecting Diagram

### 9.1 Compatibility with GRAVIS 12

Do not combine GRAVIS 12 and GRAVIS 12+ in one setup, because these speakers are not acoustically compatible.

Furthermore, separate Speaker Blocks are available for GRAVIS 12 and GRAVIS 12+.

Make sure to use the correct Speaker Blocks in order to guarantee safe operations of the speakers and an optimal result.

An 'Upgrade Kit GRAVIS 12 to GRAVIS 12+' is available and recommended for upgrading the GRAVIS 12 into a GRAVIS 12+. Ask your specialist dealer for more information.

### 9.2 Controller Mode 'Full-Range'

If you want to operate the GRAVIS 12+ in fullrange mode, then select the LSBlock Gra-12N+FR for the GRAVIS 12+ N or the Gra-12W+FR for the GRAVIS 12+ XW.

#### Notice

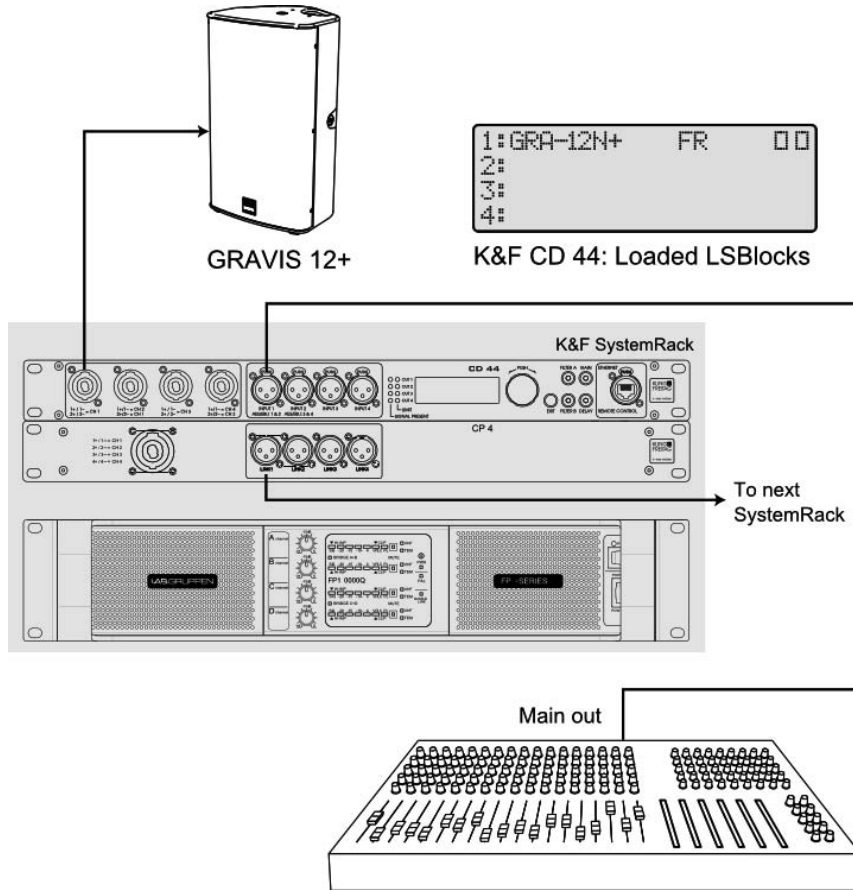

Activate the filter Cluster for the top speakers via Filter B if you wish to operate several tops next to one another.



If you need a higher bass level, activate the filter BassBoost via Filter B for the top speakers.



### 9.2.1 Controller Mode with Subwoofer in Overlap Mode

In full-range mode, the speaker GRAVIS 12+ is compatible with all K&F subwoofers that are run in the 100 Hz mode.

This so-called 'overlap mode' can make sense for surround uses when the tops should transmit the complete frequency spectrum and the subwoofer is used as an 'effect bass'.

In the overlap mode, the bass boost must not be switched on.

### 9.3 Operations with an additional Subwoofer

If you want to operate the GRAVIS 12+ with an additional K&F subwoofer, then select the LSBlock Gra-12N+LCut for the GRAVIS 12+ N or the Gra-12W LCut for the GRAVIS 12+ XW.

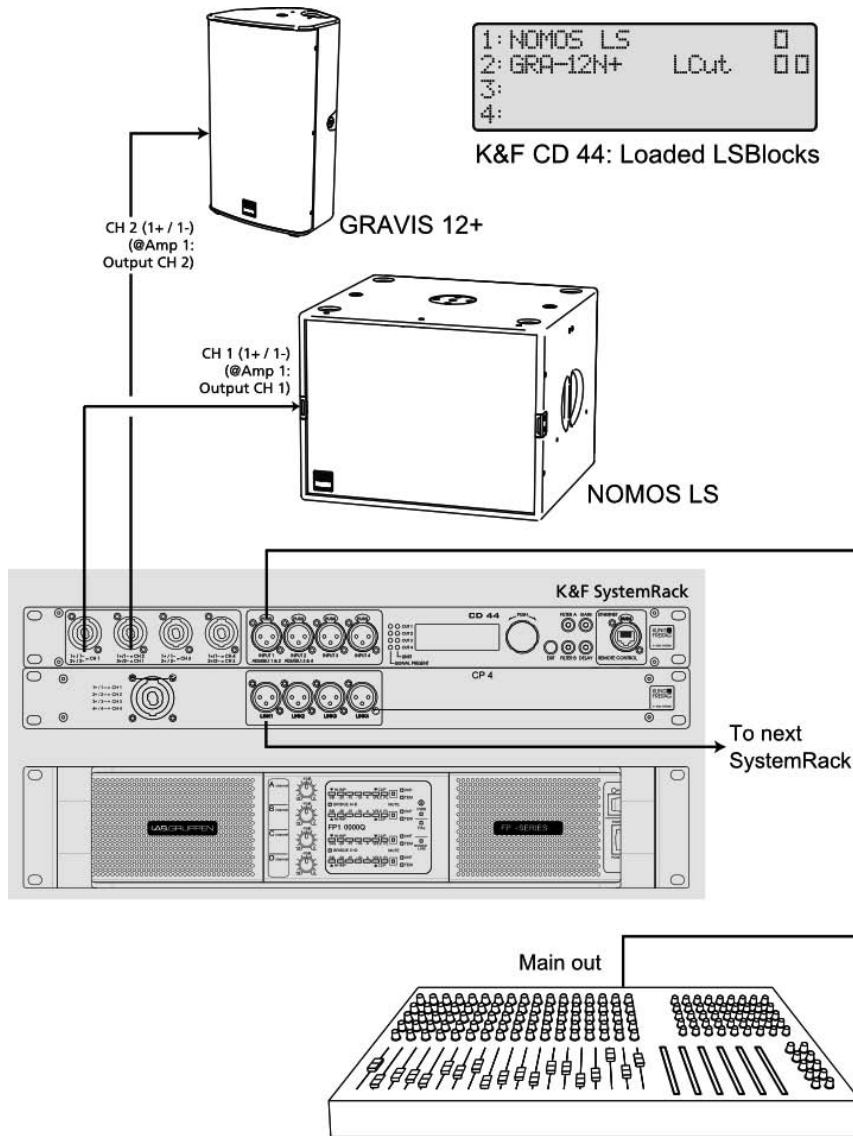

```

1: NOMOS LS      [ ]
2: GRA-12N+    LCut [ ]
3:
4:
    
```

K&F CD 44: Loaded LSBlocks

Activate the filter Cluster for the top speakers via Filter B if you wish to operate several tops next to one another.



If you need a boost in the low frequency range, activate the filter LoMidBoost via Filter B.



If necessary, adjust the correct level balance with the output gain of the subwoofer on the K&F systemamp or systemrack.

## 10. Dimensions

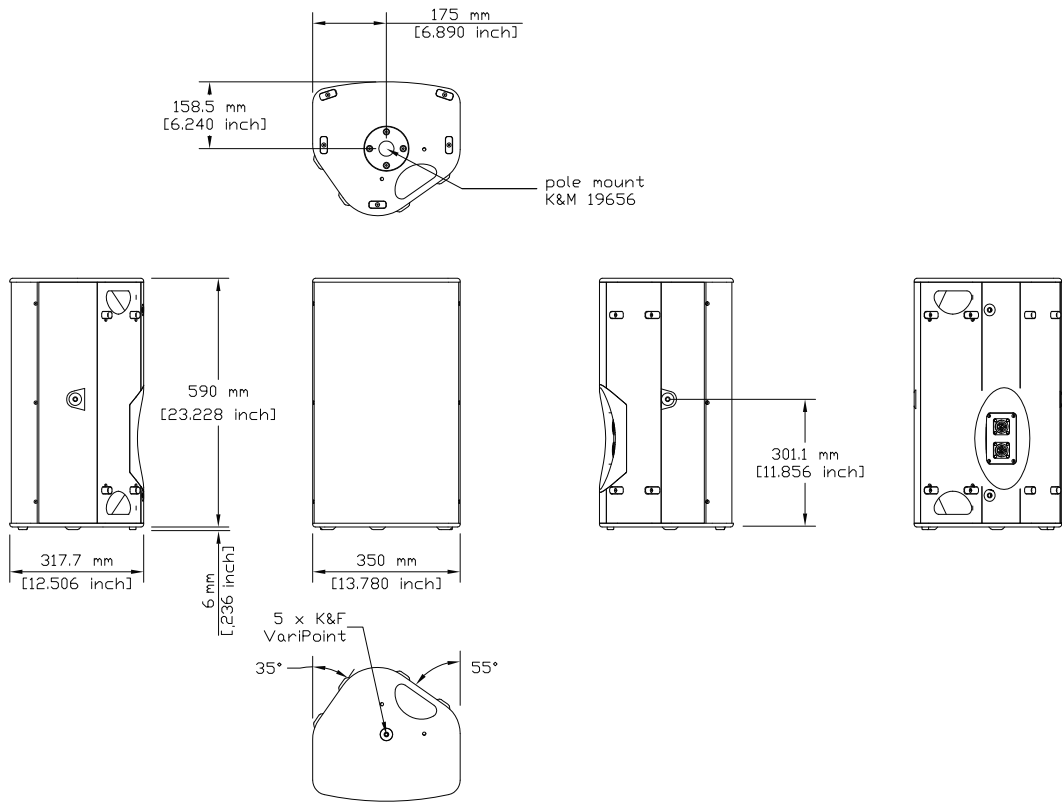

## 11. Measuring Diagrams

### 11.1 Frequency range GRAVIS 12+ N

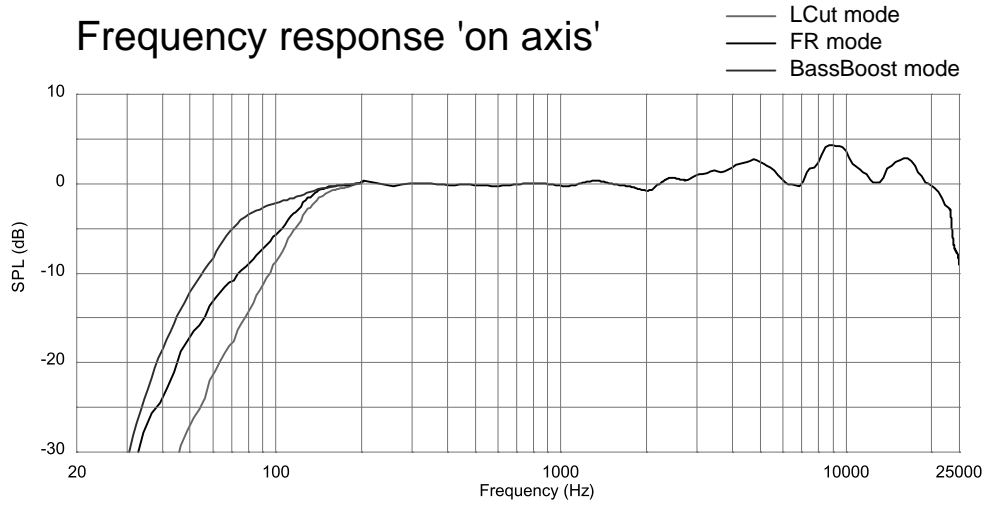

### 11.2 Frequency range GRAVIS 12+ W

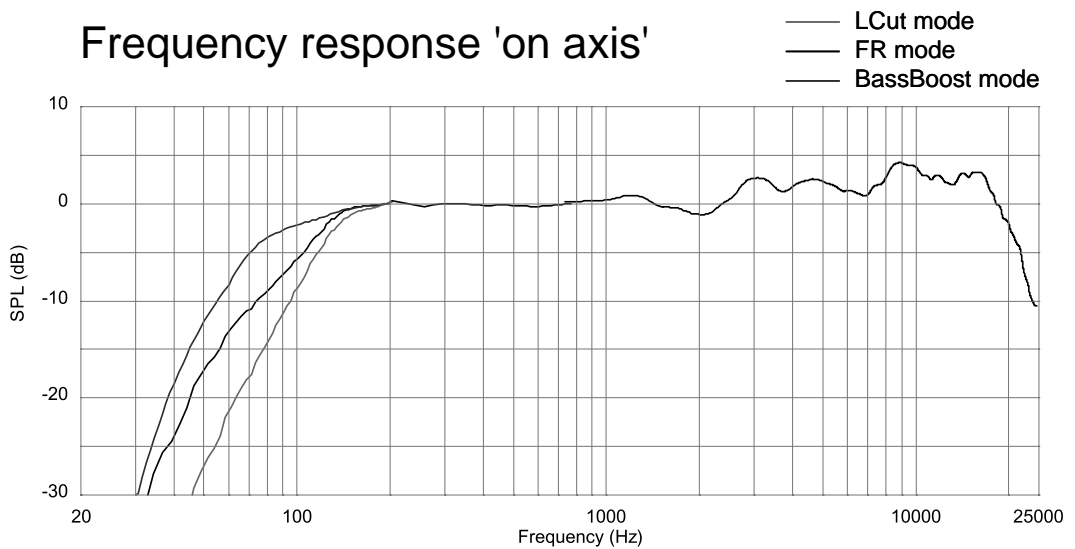

### 11.3 Frequency range GRAVIS 12+ XW

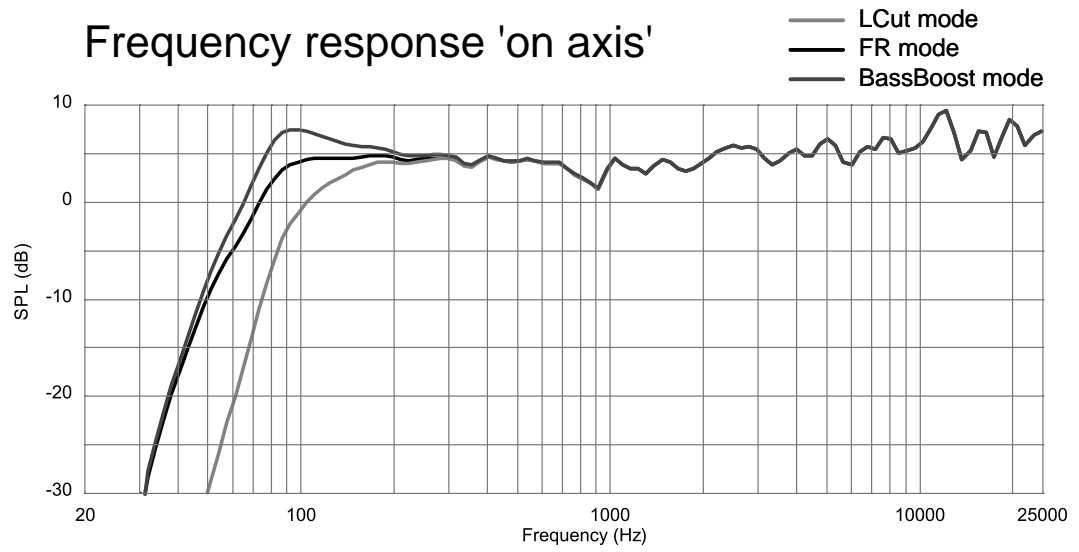

### 11.4 Coverage GRAVIS 12+ N

#### Horizontal

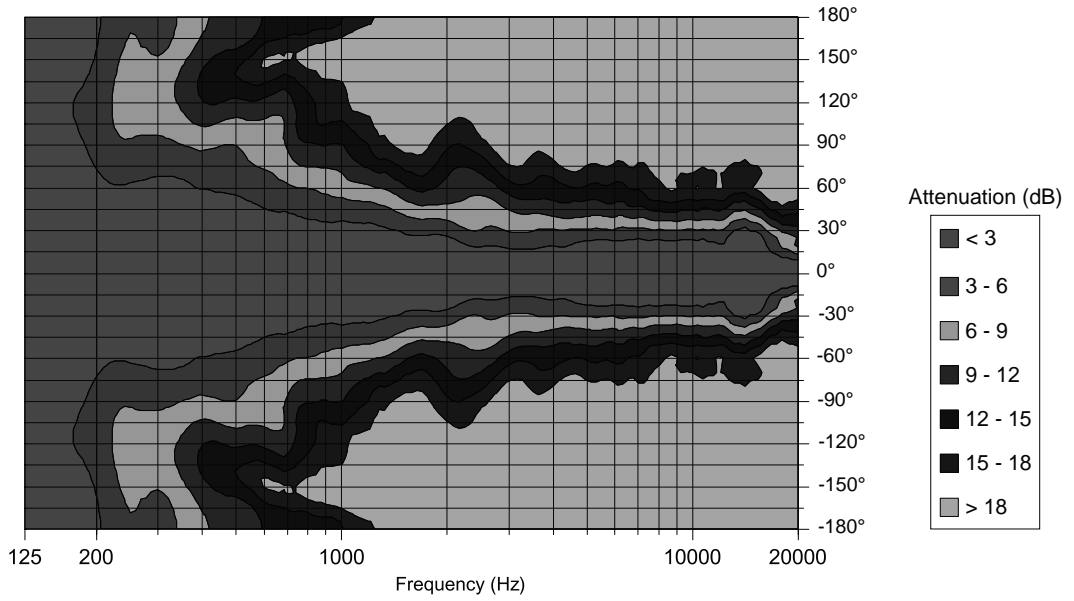

#### Vertical

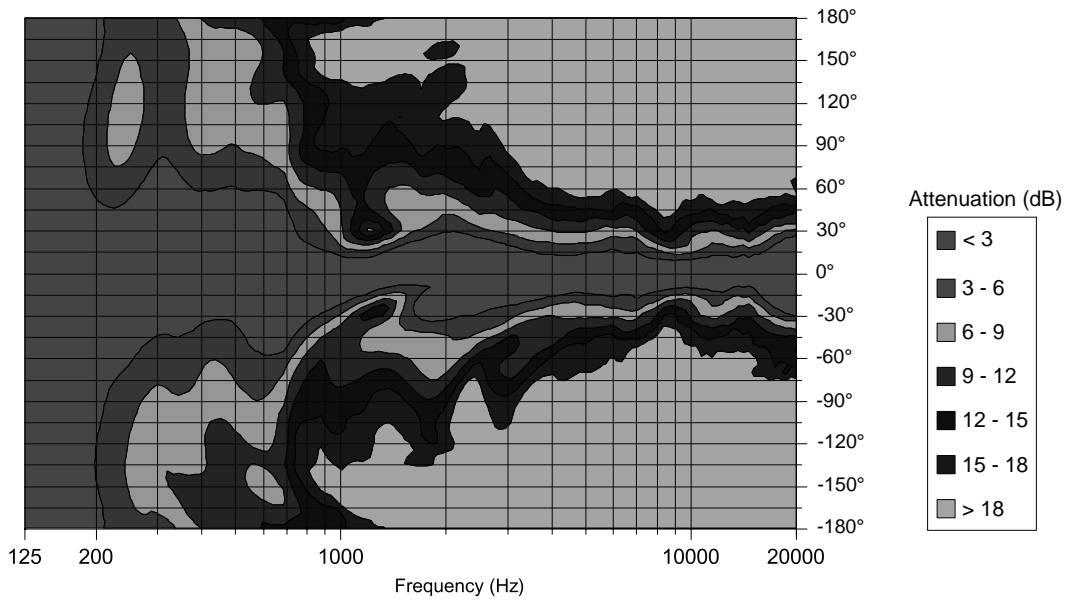

## 11.5 Coverage GRAVIS 12+ W

### Horizontal

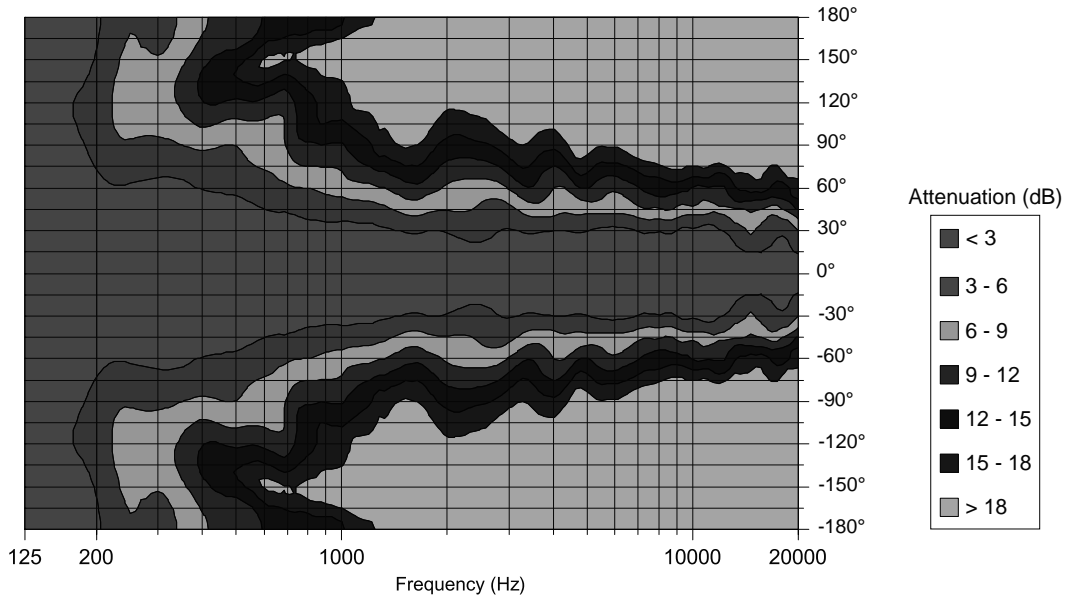

### Vertical

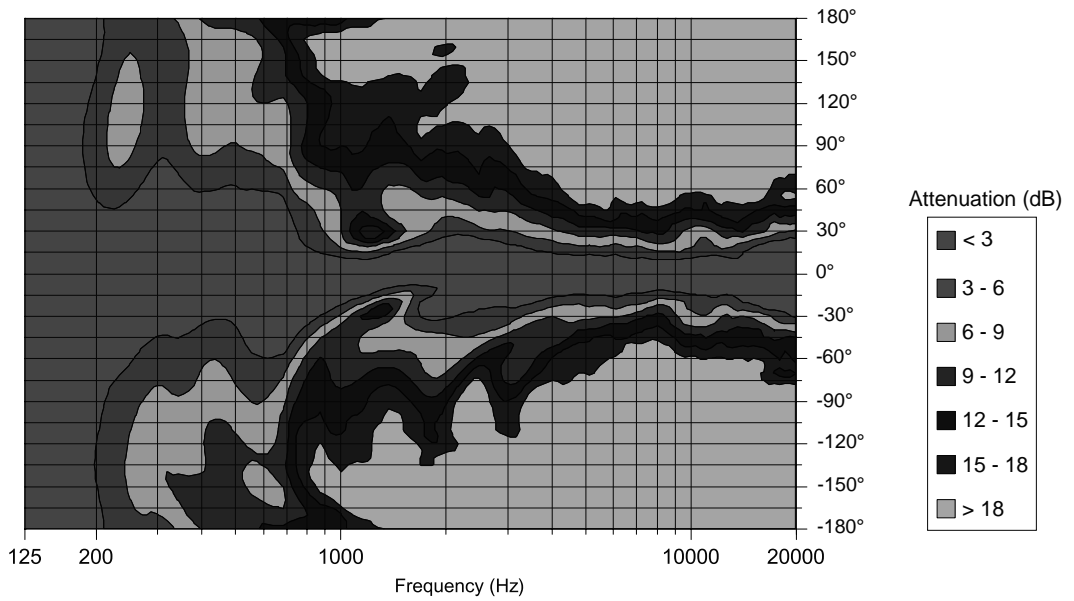

## 11.6 Coverage GRAVIS 12+ XW

### Horizontal

#### Horizontal coverage pattern

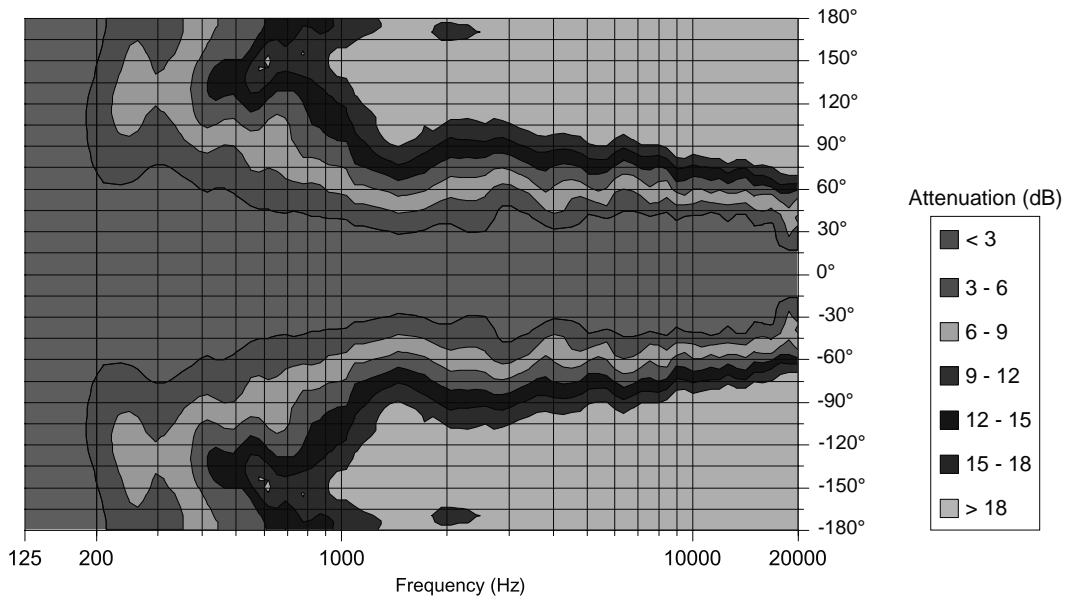

### Vertical

#### Vertical coverage pattern

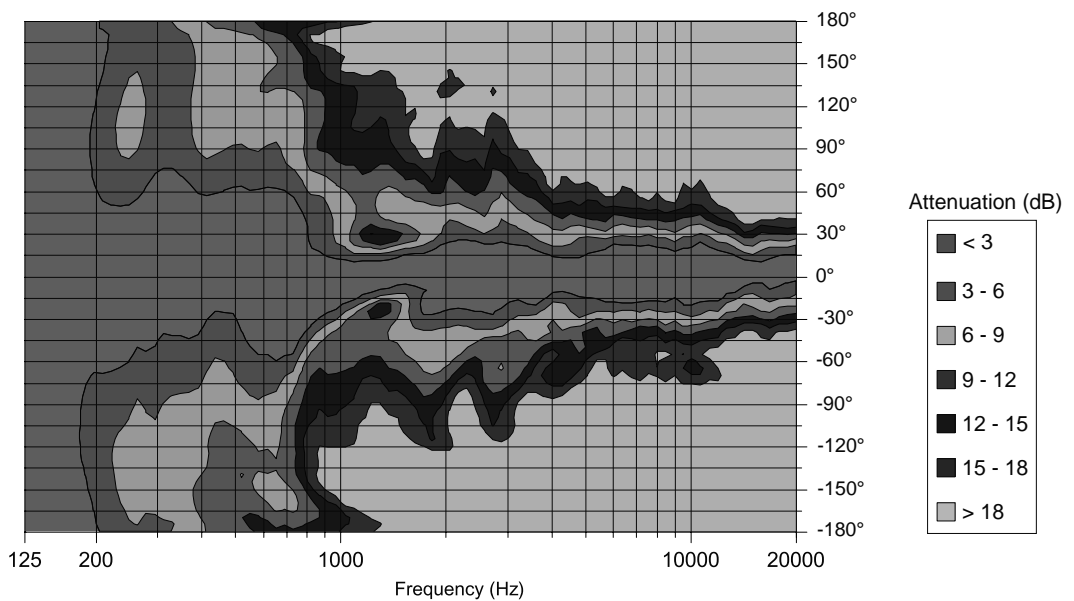

## 12. Technical Specifications

### 12.1 Technical Specifications GRAVIS 12+ W

| GRAVIS 12+ W             |  |
|--------------------------|--|
| Concept                  | Passive 2-Way-bass reflex system   |
| Operated with            | K&F PLM+ Serie, K&F D-Serie, Lab.Gruppen IPD 2400, K&F SystemRack, K&F TOPAS               |
| Frequency range @-10 dB  | 80 Hz – 23 kHz (LCut Mode)<br>65 Hz – 23 kHz (FR Mode)<br>49 Hz – 23 kHz (BassBoost Mode)  |
| Frequency range @±3 dB   | 105 Hz – 20 kHz (LCut Mode)<br>95 Hz – 20 kHz (FR Mode)<br>62 Hz – 20 kHz (BassBoost Mode) |
| Coverage angle (nominal) | 90° x 50° (hor. x vert.), rotatable Horn   |
| Nominal power handling   | 400 watts  |
| program                  | 800 watts  |
| peak                     | 1.600 watts  |
| Max. SPL (1 m)           | 134 dB SPL   |
| Impedance nominal        | 8 Ohm  |
| loudspeaker/channel      | see matrix   |
| Components               | 1.4" compression driver with 75 mm membrane<br>12" woofer                                  |
| Connection               | 2 x speakON® 4-pol NLT4MP (+1/-1),<br>IN parallel zu OUT                                   |

#### Enclosure Design

15 mm Multiplex enclosure with 35° and 55° monitor angle with highly resistable Polyurea synthetic coating in black, integrated pole mount flange, ergonomic handles on top and bottom for horizontal and vertical transport, sunk-in connector panel, 5 K&F VariPoint® for fast and safe suspension with Lifting Pin or eyebolt or to fasten Adjustable Speaker Mount or U-Mount Wall / Ceiling Bracket, 13 non-abrasive plastic sliding feet on the bottom and both monitor angles, ball proof steel grille with black acoustic foam behind the grille

|                        |                                 |
|------------------------|---------------------------------|
| Dimensions (H x W x D) | 350 x 596 x 318 mm              |
| Weight                 | 17.8 kg                         |
| Color                  | RAL 9005 (black)                |
| Options                | 'special finish in RAL colours' |

## 12.2 Technical Specifications GRAVIS 12+N

| GRAVIS 12+ N             |  |
|--------------------------|--|
| Concept                  | Passive 2-Way-bass reflex system   |
| Operated with            | K&F PLM+ Serie, K&F D-Serie, Lab.Gruppen IPD 2400, K&F SystemRack, K&F TOPAS   |
| Frequency range @-10 dB  | 80 Hz – 23 kHz (LCut Mode)<br>65 Hz – 23 kHz (FR Mode)<br>49 Hz – 23 kHz (BassBoost Mode)  |
| Frequency range @±3 dB   | 105 Hz – 20 kHz (LCut Mode)<br>95 Hz – 20 kHz (FR Mode)<br>62 Hz – 20 kHz (BassBoost Mode)   |
| Coverage angle (nominal) | 65° x 50° (hor. x vert.), rotatable Horn   |
| Nominal power handling   | 400 watts  |
| program                  | 800 watts  |
| peak                     | 1.600 watts  |
| Max. SPL (1 m)           | 134 dB SPL   |
| Impedance nominal        | 8 Ohm  |
| loudspeaker/channel      | see matrix   |
| Components               | 1.4" compression driver with 75 mm membrane<br>12" woofer  |
| Connection               | 2 x speakON® 4-pol NLT4MP (+1/-1),<br>IN parallel zu OUT   |
| Enclosure Design         |  |
|                          | 15 mm Multiplex enclosure with 35° and 55° monitor angle with highly resistable Polyurea synthetic coating in black, integrated pole mount flange, ergonomic handles on top and bottom for horizontal and vertical transport, sunk-in connector panel, 5 K&F VariPoint® for fast and safe suspension with Lifting Pin or eyebolt or to fasten Adjustable Speaker Mount or U-Mount Wall / Ceiling Bracket, 13 non-abrasive plastic sliding feet on the bottom and both monitor angles, ball proof steel grille with black acoustic foam behind the grille |
| Dimensions (H x W x D)   | 350 x 596 x 318 mm   |
| Weight                   | 17.8 kg  |
| Color                    | RAL 9005 (black)   |
| Options                  | 'special finish in RAL colours'  |

## 12.3 Technical Specifications GRAVIS 12+ XW

| GRAVIS 12+ XW            |  |
|--------------------------|--|
| Concept                  | Passive 2-Way-bass reflex system   |
| Operated with            | K&F PLM+ Serie, K&F D-Serie, Lab.Gruppen IPD 2400, K&F SystemRack, K&F TOPAS   |
| Frequency range @-10 dB  | 80 Hz – 23 kHz (LCut Mode)<br>65 Hz – 23 kHz (FR Mode)<br>49 Hz – 23 kHz (BassBoost Mode)  |
| Frequency range @±3 dB   | 105 Hz – 20 kHz (LCut Mode)<br>95 Hz – 20 kHz (FR Mode)<br>62 Hz – 20 kHz (BassBoost Mode)   |
| Coverage angle (nominal) | 110° x 50° (hor. x vert.), rotatable Horn  |
| Nominal power handling   | 400 watts  |
| program                  | 800 watts  |
| peak                     | 1.600 watts  |
| Max. SPL (1 m)           | 132 dB SPL   |
| Impedance nominal        | 8 Ohm  |
| loudspeaker/channel      | see matrix   |
| Components               | 1.4" compression driver with 75 mm membrane<br>12" woofer  |
| Connection               | 2 x speakON® 4-pol NLT4MP (+1/-1),<br>IN parallel zu OUT   |
| Enclosure Design         |  |
|                          | 15 mm Multiplex enclosure with 35° and 55° monitor angle with highly resistable Polyurea synthetic coating in black, integrated pole mount flange, ergonomic handles on top and bottom for horizontal and vertical transport, sunk-in connector panel, 5 K&F VariPoint® for fast and safe suspension with Lifting Pin or eyebolt or to fasten Adjustable Speaker Mount or U-Mount Wall / Ceiling Bracket, 13 non-abrasive plastic sliding feet on the bottom and both monitor angles, ball proof steel grille with black acoustic foam behind the grille |
| Dimensions (H x W x D)   | 350 x 596 x 318 mm   |
| Weight                   | 17.8 kg  |
| Color                    | RAL 9005 (black)   |
| Options                  | 'special finish in RAL colours'  |

## 13. EC Declaration of Conformity

applicable to all products designated hereafter and distributed by KLING & FREITAG GmbH including model variants unless these products have been altered afterwards.

### Loudspeaker systems:

|                      |                |                 |
|----------------------|----------------|-----------------|
| ACCESS B5            | E 90 MK II     | SEQUENZA 10 N/W |
| ACCESS B10           | LINE 212 -6/-9 | SEQUENZA 10 B   |
| ACCESS T5/T9         | NOMOS LS CIN   | SEQUENZA 5 W    |
| CA 106               | NOMOS LS II    | SEQUENZA 5 B    |
| CA 205 *) **)        | NOMOS LT       | SONA 5 **)      |
| CA 1001              | NOMOS XLC      | SONA 6          |
| CA 1201 *)           | NOMOS XLS      | SONA 8          |
| CA 1215 -6/-9        | NOMOS XLT      | SONA SUB **)    |
| CA 1515 -6/-9        | PASSIO **)     | SONS SUB II     |
| GRAVIS 8 W           | PASSIO SUB 12  | SW 112          |
| GRAVIS 12 N/W*       | PASSIO SUB 15  | SW 115D *)      |
| GRAVIS 12+ N/W/XW    | SCENA 15       | SW 115E         |
| GRAVIS 12+ N/W/XW AS |                | SW 118E         |
| GRAVIS 15 N/W/XW     |                | SW 212E         |

\*) These products are discontinued.

\*\*\*) These systems are not covered by the Low Voltage Directive because of the rated voltage used.

We declare that the designated product(s) are in conformity with the protection requirements imposed by the following EU directives:

|   |                              |
|---|------------------------------|
| <b>Electromagnetic Compatibility (EMC) Directive</b>  | <b>(2004/108/EC)</b>         |
| <b>Low Voltage Directive</b>  | <b>(2006/95/EC)</b>          |
| <b>Technical documentation for the assessment of electrical and electronic products with respect to the restriction of hazardous substances</b> | <b>(VDE 0042-12:2013-02)</b> |

The operating conditions specified in these user's manual must be met accordingly.

This declaration is issued under sole responsibility of the manufacturer:

**KLING & FREITAG GmbH**  
**Junkersstraße 14, D-30179 Hannover, Germany**



Hannover, 30th March 2015

Jürgen Freitag  
 (Managing Director / CEO)

---

**14. Accessories**

---

Adjustable Speaker Mount GRAVIS 12



Ceiling Bracket GRAVIS 12



Adjustable Wall Mount 50



Lifting Pin

M10 x 17 Eyebolt



Protective Cover GRAVIS 12



Stand socket M10



---

Pipe Clamp for TV Spigot



---

TV Spigot 20 mm



---

Spigot 20 mm



## 15. Care and Maintenance



Warning

1. For the owner and user, it is mandatory to be aware of the safety relevance of speakers that can be flown.

Note that the mains cable is supplied with either a connector appropriate for the place of delivery (see item number) or with open terminals (on the mains side).

The GRAVIS 12+ system can exhibit signs of wear over the years, for example, from mechanical strain, transport damage, corrosion, or improper handling. Remember that flying speakers always impose a high safety risk.

Generally, perform a visual inspection of your speaker every time you suspend it or take it down. In fixed installations, check the speaker for signs of wear at regular intervals.

When performing those checks, particularly look for deformations, cracks, dents, damage to threads, and corrosion. Also check slings and lifts (e.g. shackles, chains, and steel ropes) carefully for wear and deformation.

If as a result of these checks any uncertainty should arise with regard to safety or defects are found, don't use the speaker any longer.

**Inspection regulations may vary depending on application and country of use. Observe all applicable regulations; when in doubt, contact the local authorities.**

Many countries require regular inspection of mounting components and accessories. An additional annual inspection is typically required to be performed by a technical expert. Moreover, a legally certified or official authority must perform a detailed inspection every four years.

Therefore, be sure to maintain an inspection log. Enter the values determined for each speaker and accessory during the periodic checks into this log. This way, relevant data are always at hand in case of inspection. The log should also document maintenance measures and inspection intervals and contain parts lists.

2. The Polyurea synthetic coating used by KLING & FREITAG is impact proof and highly resistant. We recommend using protective coverings or transport cases to help avoid damaging the paint in case of continuous mobile use, etc.
3. To replace the filter foam, send the front grille incl. foam to KLING & FREITAG GMBH. Upon payment for expenses, the grille with the new covering will be returned.

## 16. Transportation and Storage

The GRAVIS 12+ is protected against short-term moisture. despite, be sure to store, transport, and use the accessories in dry environments only. The GRAVIS 12+ System is not designed for long-term use in a corrosive environment.

Make sure that the system is adequately ventilated during longer storage periods so any residual moisture can escape from the equipment.

Furthermore, you should ensure that the GRAVIS 12+ System is protected from mechanical strain to prevent possible damage.

We recommend using suitable transport and storage cases and the optional soft cover that protects from the above-mentioned influences.

## 17. Disposal

Recycle the packaging material of the device.

### 17.1 Germany

**Don't dispose of waste electrical equipment through household waste.**

**Don't deliver it to official recycling points either.**

All KLING & FREITAG products are plain business-to-business (B2B) products. Therefore, KLING & FREITAG GmbH is exclusively responsible for disposing of all KLING & FREITAG waste equipment marked with a garbage-can icon. Call the below phone number when you have a KLING & FREITAG product (marked with the garbage-can icon) for disposal. We will offer you a straightforward and professional disposal at no cost.



KLING & FREITAG equipment with no such icon was sold before 24 March 2006; in that case, the owner is legally responsible for disposal. We will, however, gladly assist you by naming appropriate ways of disposal.

For further disposal information of KLING & FREITAG waste products, call +49 (0)511-96 99 7-0

Background information: The Electrical and Electronic Equipment and Appliances Act (ElektroG) is the German implementation of the European (EU) Waste Electrical and Electronic Equipment Directive (WEEE, 2002/96/EC).

Therefore, starting on 24 March 2006, KLING & FREITAG GmbH has marked all products subject to the WEEE that are distributed in Germany with an icon showing a crossed-out garbage can with a white bar below it. The icon indicates that the equipment was distributed on or after 24 March 2006 and must not be disposed of through household waste.

KLING & FREITAG GmbH is legally registered as a manufacturer with the German waste-equipment registration authority (EAR). The WEEE registration number is: DE64110372.

We substantiated towards the EAR that our products are for B2B trade only.

## 17.2 EU, Norway, Iceland, and Liechtenstein

**Don't dispose of waste electrical equipment through household waste.**

Starting on 13 August 2005, KLING & FREITAG GMBH has marked all products subject to the WEEE directive that are distributed in any member state of the European Union (except Germany), Norway, Iceland, or Liechtenstein with an icon showing a crossed-out garbage can with a white bar below it.



The icon indicates that the equipment was distributed on or after 13 August 2005 and must not be disposed of through household waste.

Unfortunately, the European WEEE directive was implemented in different national legislation in the EU member states, making it impossible to offer a consistent disposal solution throughout Europe.

The local distributor (sales partner) in the respective country is responsible for complying with the applicable legislation.

Contact your retailer or the local authorities for information on the regulations applicable in any EU member state (except Germany).

## 17.3 All Other Countries

Contact your retailer or the local authorities for information on the regulations applicable in any country not listed above.

---

## INDEX

|                                     |    |
|-------------------------------------|----|
| • Accessories.....                  | 27 |
| • Care.....                         | 29 |
| • Components.....                   | 7  |
| • Connection.....                   | 14 |
| • Dimensions.....                   | 17 |
| • Disposal.....                     | 29 |
| • EC Declaration of Conformity..... | 26 |
| • High frequency horn.....          | 12 |
| • InstallSound.....                 | 6  |
| • Items Included.....               | 6  |
| • Maintenance.....                  | 29 |
| • Measuring Diagrams.....           | 18 |
| • Mounting.....                     | 10 |
| • Operating Safety.....             | 8  |
| • Product Description.....          | 6  |
| • ProRental.....                    | 6  |
| • Protecting the Speakers.....      | 8  |
| • Safety Instructions.....          | 8  |
| • Secondary Safety Device.....      | 10 |
| • Setup.....                        | 14 |
| • SystemAmp.....                    | 6  |
| • SystemRack.....                   | 6  |
| • System Requirements.....          | 6  |
| • Technical Specifications.....     | 23 |
| • Tool.....                         | 12 |